

## Lithium Iron Phosphate (LiFePO4) Battery Specification

### SLAUMXLI200-12(12.8V200AH)



#### Specifications

Nominal Voltage		12.8V
Rated capacity (20 hour rate)		200Ah at 0.2C
Dimensions	Total Height	220 mm
	Height	220 mm
	Length	500 mm
	Width	225 mm
Weight Approx		26Kg
Terminal		M8

#### Characteristics

Capacity Retention		>80% at 28 days
Cycle Life		>80% at 2000 Cycles
1.5 hour discharge to 10.5V		80.0 A
Internal Resistance		<20 mΩ
Charge Characteristics	Charge Voltage	14.4±0.1V
	Charger Current	<40A
	Max Charge Current	<150A
Discharge Characteristics	Continuous Current	150A
	Discharge Cut-off Voltage	10V
	Peak Discharge Current	450A / 1 sec
Temperature	Charge Temperature	0°C-45°C(32°F-113°F)
	Discharge Temperature	-20°C-60°C(-4°F-140°F)
	Storage Temperature	0°C-40°C(32°F-104°F)

#### Cycle Lives Curves

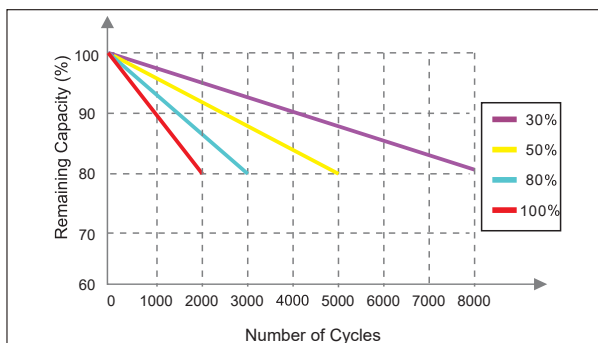

#### Outer dimensions (mm)

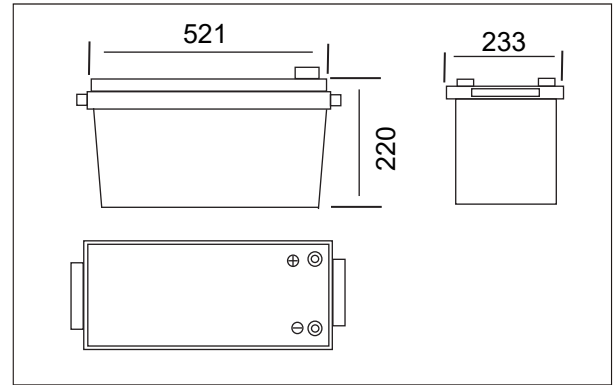

#### Terminal Type (mm)

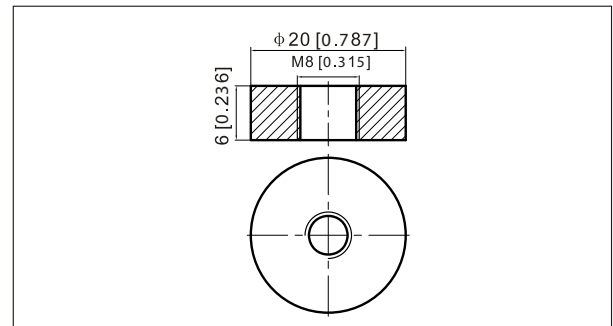

#### Discharge Curves 25°C(77°F)

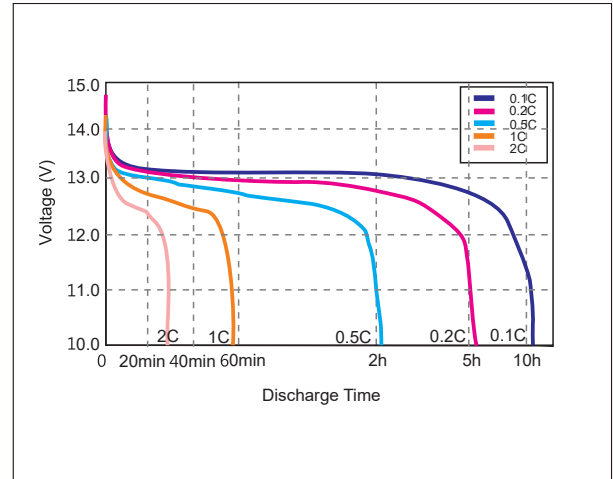

#### Temperature Discharge Curve @0.5C

