

# mze

## MZ ELECTRONIC

---

### Istruzioni per l'uso

*Instructions for use*

*Instructions d'utilisation*

*Gebrauchsanweisung*

*Instrucciones de uso*



**CONTAMETRI**

*CHAIN COUNTER*

*COMPTEUR MÉTRIQUE*

*METERZÄHLER*

*CUENTAMETROS*



**HC020**

---

Rev. 03-2021

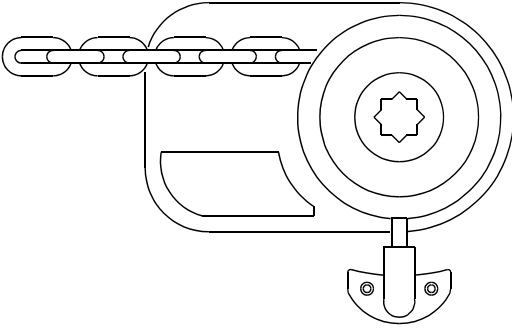

**Fig. 1A**

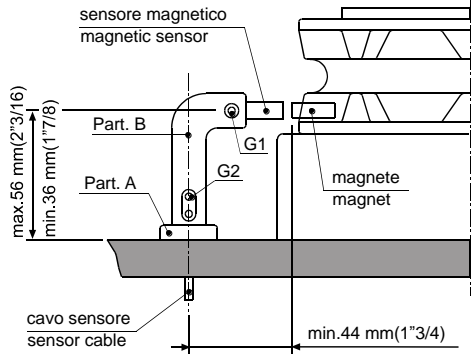

**Fig. 1B**

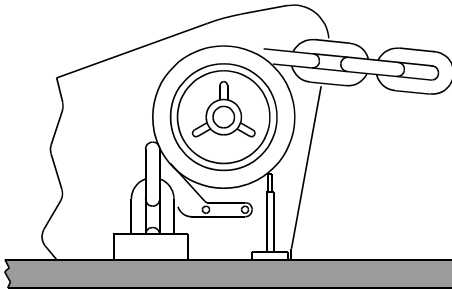

**Fig. 2A**

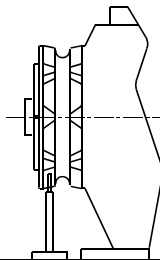

**Fig. 2B**

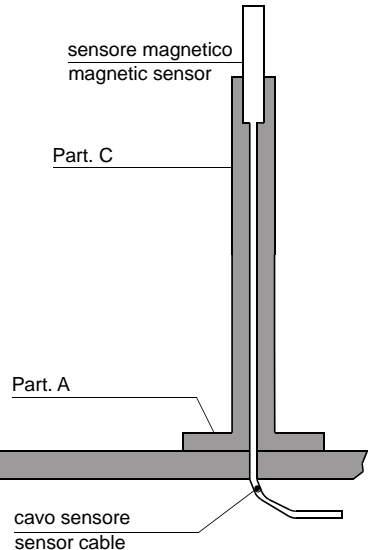

**Fig. 2C**

## Descrizione

Il contametri **HC020** permette di salpare o calare un'ancora con la visualizzazione dei metri o piedi di catena svolta e della velocità della stessa.

## Dati tecnici

Tensione di alimentazione	da 10 a 30 V DC
Assorbimento di corrente	min. 5 mA – max 60 mA
Grado di protezione	IP67
Temperatura operativa	0 / +70 °C (32 / 158 °F)
Display grafico	128 x 128 pixel
Misura massima raggiungibile	999 metri – 999 piedi
Dimensioni (mm)	170 x 80 x 50
Peso (g)	450*

\* compreso il cavo



**Attenzione**

**ALIMENTARE ESCLUSIVAMENTE IN CORRENTE CONTINUA.**

## Note generali

Il contametri **HC020** deve essere utilizzato per gli scopi descritti in questo manuale – azionamento e visualizzazione dei metri/piedi di catena svolti da un salpa ancora o azionamento di un tonneggio. Qualunque altro utilizzo è da ritenersi un uso improprio.

**La manomissione dello strumento provoca il decadimento immediato della garanzia.**

## Componenti

**La confezione contiene:**

contametri con cavo estensibile e kit di fissaggio (1 staffa con 2 viti);  
presa connettore a 6 poli con guarnizione, 4 viti di fissaggio con anelli distanziali e tappo di chiusura;  
istruzioni per l'uso.

## Installazione

**Su alcuni modelli di salpa ancora il sensore ed il magnete sono stati già installati (predisposizione contametri) non è quindi necessario eseguire le operazioni indicate di seguito.**

### **Installazione del magnete sul salpa ancora**

Il foro da praticare su un dente del barbotin - del diametro di 6,5 mm (~1/4") e della profondità di 8 mm (5/16") - deve trovarsi in una zona non interessata dal passaggio della catena.

Per i salpa ancora ad asse verticale (vedi Fig. 1B) eseguire la foratura nella circonferenza inferiore del barbotin.

Per i salpa ancora ad asse orizzontale (vedi Fig. 2B) eseguire la foratura sulla circonferenza esterna del barbotin.

Verificare, inoltre, che la parte sporgente del magnete, durante la rotazione del barbotin, non urti contro la base o il sensore.

Inserire il magnete, nel foro, dalla parte metallica lasciando sporgere la parte protetta di circa 2 mm. Fissarlo utilizzando un collante per metalli (colla epossidica bi-componente) o silicone. Il collante utilizzato deve essere resistente all'ambiente marino.

### Montaggio sensore magnetico per salpa ancora ad asse verticale

(vedi Fig. 1A – 1B)

Praticare nella coperta un foro del diametro di 4 mm (~3/16") per il passaggio del cavo del sensore.

Fissare il Part. A del supporto, con le due viti a corredo, dopo avere posizionato nella parte inferiore dello stesso la guarnizione OR.

Inserire il Part. B, con il sensore magnetico, sul supporto A e regolarlo in altezza in modo che si trovi in asse con il magnete fissato sul barbotin.

Avvicinare il sensore a circa 3 mm (~1/8") dal magnete e fissarlo serrando la vite G1. Serrare successivamente la vite G2.

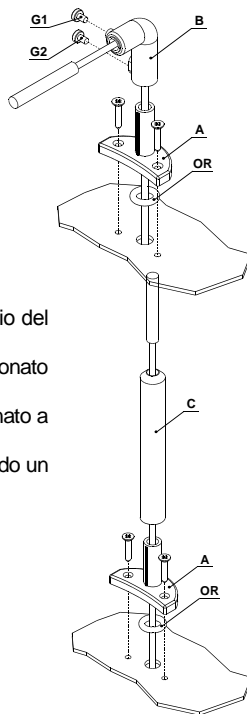

### Montaggio sensore magnetico per salpa ancora ad asse orizzontale

(vedi Fig. 2A – 2B – 2C)

Praticare nella coperta un foro del diametro di 4 mm (~3/16") per il passaggio del cavo del sensore.

Fissare il Part. A del supporto, con le due viti a corredo, dopo avere posizionato nella parte inferiore dello stesso la guarnizione OR.

Tagliare, con un seghetto, a misura il Part. C. Il sensore deve essere posizionato a circa 3 mm (~1/8") dal magnete.

Inserire il Part. C, con il sensore magnetico, sul supporto A e fissarlo utilizzando un collante per materiali plastici (colla epossidica bi-componente) o silicone.

Fissare, con lo stesso collante, il sensore al Part. C.

### Installazione contametri

(vedi schema elettrico)



**Attenzione**

**STACCARE SEMPRE LA BATTERIA PRIMA DI PROCEDERE ALL'INSTALLAZIONE.**

Il contametri deve essere posizionato in modo che il display sia facilmente leggibile e non esposto ai raggi solari.

Fissare lo strumento con la staffa in dotazione serrando le due viti con un cacciavite a croce.

Praticare, sulla plancia, un foro da 20,5 mm (~13/16") e 4 fori da 2,2 mm (~3/32") per il fissaggio della presa del connettore.

La guarnizione deve essere interposta tra la presa e la plancia.

La parte posteriore deve essere protetta dal contatto di acqua o di umidità.

Per il collegamento elettrico seguire le indicazioni dello schema allegato. I cavi devono avere una sezione minima di 1,5 mm<sup>2</sup>.

Montare un fusibile di protezione rapido da 3 A (ampere) sul cavo + della batteria. Non utilizzare per l'alimentazione la tensione proveniente dal gruppo batterie motori.

Lo strumento risponde agli standard EMC (EN55022) e deve essere posizionato a una distanza di:

- 30 cm (~1 Ft) dalla bussola;
- 50 cm (~1,5 Ft) da apparecchi radio;
- 2 metri (~6,5 Ft) da apparecchi radiotrasmettenti;
- 2 metri (~6,5 Ft) dal fascio radar.

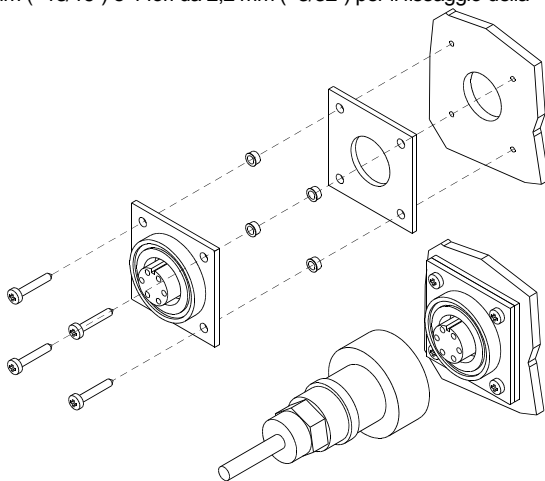

**Collegamenti (vedere collegamenti in fondo al manuale)**

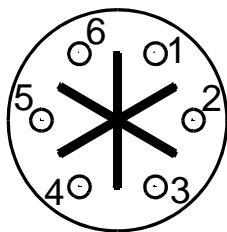

CONNETTORE POSTERIORE A 6 POLI	
PIN	SEGNALE
1	- batteria
2	+ batteria
3	Comando DOWN
4	Comando UP
5	Sensore magnetico
6	

### Foratura connettore e sensore

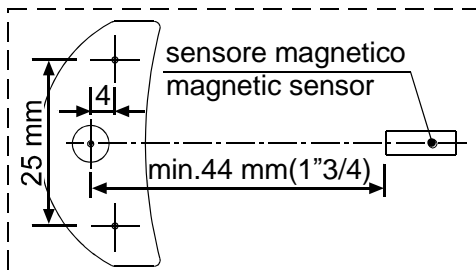
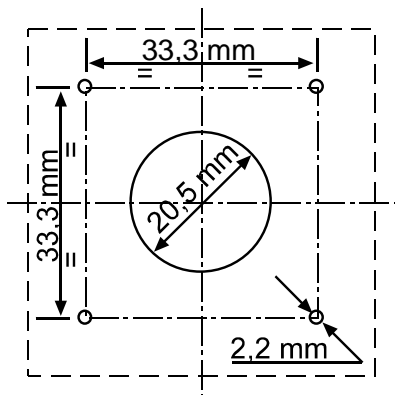

### Prima accensione

Il contametri è dotato di un *display* grafico e di tre tasti: **ON**, **UP** e **DOWN**. Il tasto **ON** accende il *display* e abilita gli altri due tasti. Deve essere utilizzato per accedere ai menù di impostazione dei parametri, per selezionare i parametri da modificare e per confermare i valori impostati. Lo spegnimento dell'illuminazione del *display* avviene 30 secondi dopo l'ultimo comando dato (modificabile nel menù impostazioni).

Il tasto **UP** comanda la salita dell'ancora mentre il tasto **DOWN** la cala. Al rilascio di ogni tasto la relativa manovra si interrompe. I due tasti, durante l'impostazione dei parametri, permettono il movimento all'interno del menù e la variazione del valore dei parametri.

All'accensione comparirà per alcuni secondi la schermata iniziale:



Completata la procedura di inizializzazione viene visualizzata la schermata principale con l'indicazione della lunghezza di catena:



**BARRA DI STATO:** indica il comando attivo ovvero quello in funzione

**UNITA' DI MISURA:** metri oppure piedi

**ANIMAZIONE:** viene visualizzata una catena oppure un tonnellaggio per indicare il verso di movimento

**MISURA CATENA:** indica la misura della catena calata (in metri o piedi).

**CAMBIO MODALITA':** questa icona appare al cambio modalità verricello / tonnellaggio

**VELOCITA':** indica la velocità della catena, in salita o discesa, in metri al minuto (mt/m) o piedi al minuto (ft/m)

**TENSIONE BATTERIA:** viene visualizzata la tensione di batteria che alimenta lo strumento

Alla prima accensione lo strumento si predisporrà come da impostazione all'uscita dalla fabbrica (vedi tabella).

Parametro	Valore di default
Allarme salita	3.0 metri
Discesa automatica	Off
Tempo BackLight	30 secondi
Unità di misura	Metri/centimetri
Misura catena	0.0 metri
Circonferenza Barbotin	33 cm
Tipo sensore	Standard
Lingua	Italiano
Ore Funzionamento	0
Fattore di divisione	1

## Modalità verricello / tonneggio

Il contametri HC020 presenta due differenti modi di funzionamento: modalità verricello e modalità tonneggio.

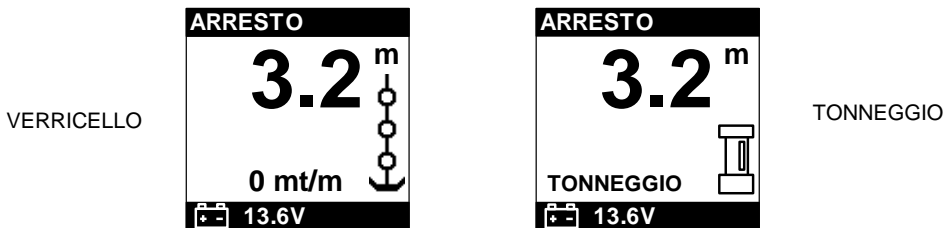

Quando lo strumento viene acceso si posiziona nella modalità verricello che è quindi quella standard di funzionamento: è possibile azionare il verricello ottenendo la misura dei metri di catena calati, il calcolo della velocità dell'ancora ed eventualmente la segnalazione di errore sensore in caso di anomalie o guasti sul sensore contagiri installato a bordo del verricello.

Nella modalità tonneggio invece viene azionato il tonneggio per le normali operazioni di attracco in porto ma senza la lettura del sensore contagiri; in questa modalità quindi la lunghezza di catena non varia, la velocità della catena non viene visualizzata e non viene data nessuna segnalazione sullo stato del sensore che di fatto non è in uso in quanto la catena è ferma.

Per passare da una modalità all'altra è necessario premere il pulsante **Ⓞ (ON)** per 3 secondi per far apparire l'icona di cambio modalità:



quando appare rilasciare il pulsante **Ⓞ (ON)** per cambiare da verricello a tonneggio o viceversa.

## Menù di impostazione contametri

Mantenendo premuto il tasto **Ⓞ (ON)**, per sei secondi, si accede al menù di impostazione dello strumento. Sul *display* comparirà la seguente schermata.

Utilizzare il tasto **⏴ (DOWN)** e **⏵ (UP)** per spostarsi tra le voci del menù.

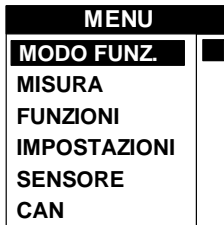

Quando si è posizionati sulla voce da modificare premere il tasto **Ⓞ (ON)** per confermare la scelta.



Utilizzare i tasti $\nabla$ ( <b>DOWN</b> ) o $\triangle$ ( <b>UP</b> ) per spostarsi tra i parametri.
Quando si è posizionati sul parametro premere il tasto $\text{ON}$ ( <b>ON</b> ) per abilitare la modifica.
In funzione del tipo di parametro, utilizzando il tasto $\nabla$ ( <b>DOWN</b> ) e $\triangle$ ( <b>UP</b> ), è possibile diminuire/aumentare il valore dello stesso o disabilitare/abilitare la funzione.
Quando è stata effettuata la modifica premere il tasto $\text{ON}$ ( <b>ON</b> ) per confermare.
Utilizzando il tasto $\nabla$ ( <b>DOWN</b> ) portarsi sulla voce <b>Uscita</b> e ripremere il tasto $\text{ON}$ ( <b>ON</b> ) per ritornare al menù di impostazione. La stessa procedura deve essere utilizzata per ritornare alla pagina principale.

### Menù Modo di Funzionamento











<div style="border: 1px solid black; padding: 5px; margin: 0 auto; width: fit-content;"> <p><b>MODO FUNZ.</b></p> <p><b>MODO FUNZ. TON</b></p> <p><b>USCITA</b></p> </div>	
Utilizzare i tasti $\nabla$ ( <b>DOWN</b> ) o $\triangle$ ( <b>UP</b> ) per spostarsi tra i parametri.	
<p><b>Modo Funz.</b></p> <p>Seleziona la modalità di funzionamento:</p> <ul style="list-style-type: none"> <li>• Verricello (VER)</li> <li>• Tonneggio (TON)</li> </ul>	<p>Selezionare con <math>\text{ON}</math></p> <p>Cambiare con <math>\nabla/\triangle</math></p> <p>Confermare con <math>\text{ON}</math></p>
<p><b>Uscita</b></p> <p>Per ritornare al menù precedente</p>	<p>Confermare con <math>\text{ON}</math></p>

**Menù Misura**











<table border="1" style="margin: auto;"> <tr><th colspan="2">MISURA</th></tr> <tr><th colspan="2">AZZERA</th></tr> <tr><td>UNITA M.</td><td>MET</td></tr> <tr><td colspan="2">USCITA</td></tr> </table>		MISURA		AZZERA		UNITA M.	MET	USCITA	
MISURA									
AZZERA									
UNITA M.	MET								
USCITA									
Utilizzare i tasti $\nabla$ (DOWN) o $\triangle$ (UP) per spostarsi tra i parametri.									
<b>Azzerà Misura</b> Azzerà il valore della misura della catena (0.0).	Selezionare con $\text{Ⓢ}$ $\nabla$ = Sì $\triangle$ = No Confermare con $\text{Ⓢ}$								
<b>Unità Misura</b> Si seleziona l'unità di misura: <ul style="list-style-type: none"> <li>• Piedi / pollici (PIE)</li> <li>• Metri / centimetri (MET)</li> </ul>	Selezionare con $\text{Ⓢ}$ $\triangle$ = Piedi $\nabla$ = Metri Confermare con $\text{Ⓢ}$								
<b>Uscita</b> Per ritornare al menù precedente	Confermare con $\text{Ⓢ}$								









**Menù Funzioni**

<table border="1" style="margin: auto;"> <tr><th colspan="2">FUNZIONI</th></tr> <tr><td>AL. SALITA</td><td>2.5</td></tr> <tr><td>DISCESA</td><td>OFF</td></tr> <tr><td colspan="2">DEFAULT</td></tr> <tr><td colspan="2">USCITA</td></tr> </table>		FUNZIONI		AL. SALITA	2.5	DISCESA	OFF	DEFAULT		USCITA	
FUNZIONI											
AL. SALITA	2.5										
DISCESA	OFF										
DEFAULT											
USCITA											
Utilizzare i tasti $\nabla$ (DOWN) o $\triangle$ (UP) per spostarsi tra i parametri.											
<b>Allarme Salita</b> È possibile abilitare la funzione e stabilire la quota alla quale il salpa ancora si arresta; la manovra può essere completata rilasciando il pulsante UP e premendolo nuovamente.	Selezionare con $\text{Ⓢ}$ Impostare il valore con $\triangle$ $\nabla$ Confermare con $\text{Ⓢ}$										















Valore impostabile: OFF, 0.5 – 1.0 – 1.5 – 2.0 – 2.5 – ...10.0 (metri o piedi).	
<p><b>Discesa Automatica</b> Abilita la procedura di discesa automatica dell'ancora, alla quota desiderata, con la pressione (per almeno 3 sec.) dei tasti  e .</p> <p>Valore impostabile: OFF, 1,2,3...25 (metri o piedi).</p>	<p>Selezionare con </p> <p>Impostare il valore con  </p> <p>Confermare con </p>
<p><b>Dati Fabbrica</b> Questa funzione permette di richiamare i dati originali, impostati in fabbrica, <u>cancellando le impostazioni memorizzate</u>.</p> <p><b>Usare questo comando solo in caso di una errata programmazione.</b></p>	<p>Selezionare con </p> <p> = Si    = No</p> <p>Confermare con </p>
<p><b>Uscita</b> Per ritornare al menù precedente.</p>	Confermare con 

## Menù Impostazioni

<table border="1" style="margin: auto;"> <tr> <th colspan="2">IMPOSTAZIONI</th> </tr> <tr> <td>CONTRASTO</td> <td style="text-align: right;">3</td> </tr> <tr> <td>LUCE LCD</td> <td style="text-align: right;">5</td> </tr> <tr> <td>TEMPO OFF</td> <td style="text-align: right;">30</td> </tr> <tr> <td>LINGUA</td> <td style="text-align: right;">ITA</td> </tr> <tr> <td>USCITA</td> <td></td> </tr> </table>		IMPOSTAZIONI		CONTRASTO	3	LUCE LCD	5	TEMPO OFF	30	LINGUA	ITA	USCITA	
IMPOSTAZIONI													
CONTRASTO	3												
LUCE LCD	5												
TEMPO OFF	30												
LINGUA	ITA												
USCITA													
Utilizzare i tasti  ( <b>DOWN</b> ) o  ( <b>UP</b> ) per spostarsi tra i parametri.													
<p><b>Contrasto</b> Abilitando questa funzione è possibile avviare la procedura di programmazione del contrasto del <i>display</i>.</p>	<p>Selezionare con </p> <p>Impostare il valore con  </p> <p>Confermare con </p>												
<p><b>Luce LCD</b> Abilitando questa funzione è possibile avviare la procedura di programmazione dell'intensità della luce del <i>display</i>.</p>	<p>Selezionare con </p> <p>Impostare il valore con  </p> <p>Confermare con </p>												
<p><b>Tempo OFF</b> Questa funzione permette di impostare il</p>	Selezionare con 												





tempo di accensione della luce durante il quale il <i>display</i> rimane acceso dopo l'ultimo comando dato (valore di default 30 secondi). Quando la luce si spegne i pulsanti UP/DOWN sono disabilitati ed è necessario premere ON per abilitarli nuovamente.	Impostare il valore con   Confermare con 
<b>Lingua</b> Questo comando permette di modificare la lingua impostata sullo strumento tra quelle disponibili (italiano, inglese, francese, tedesco, spagnolo)	Selezionare con  Impostare il valore con   Confermare con 
<b>Uscita</b> Per ritornare al menù precedente	Confermare con 

**Menù Sensore**

<table border="1" style="margin: auto;"> <thead> <tr> <th colspan="2">SENSORE</th> </tr> <tr> <th>SENSORE</th> <th>STD</th> </tr> </thead> <tbody> <tr> <td>BARBOTIN</td> <td>33.0</td> </tr> <tr> <td>DIVISORE</td> <td>1</td> </tr> <tr> <td>TEST</td> <td></td> </tr> <tr> <td>USCITA</td> <td></td> </tr> </tbody> </table>		SENSORE		SENSORE	STD	BARBOTIN	33.0	DIVISORE	1	TEST		USCITA	
SENSORE													
SENSORE	STD												
BARBOTIN	33.0												
DIVISORE	1												
TEST													
USCITA													
Utilizzare i tasti  ( <b>DOWN</b> ) o  ( <b>UP</b> ) per spostarsi tra i parametri.													
<b>Sensore</b> Consente di impostare il tipo di sensore: <ul style="list-style-type: none"> <li>• Standard ovvero a 2 fili (STD)</li> <li>• Elettronico ovvero a 3 fili (HAL)</li> </ul>	Selezionare con  Impostare il valore con   Confermare con 												
<b>Circonferenza Barbotin</b> In questa riga si deve inserire la circonferenza del Barbotin (in centimetri o pollici). Per inserire il valore corretto vedere il paragrafo "Calibrazione dello strumento".	Selezionare con  Impostare il valore con   Confermare con 												
<b>Divisore</b> Se viene utilizzato il sensore standard a 2 fili (STD) questo valore va lasciato a 1. se si utilizza un sensore elettronico deve essere pari al numero di impulsi del sensore per ogni giro di barbotin. Vedere il paragrafo "Calibrazione dello strumento".	Selezionare con  Impostare il valore con   Confermare con 												

<p><b>Test</b> Questa funzione consente di verificare il corretto funzionamento del sensore contagiri: viene visualizzata una schermata con lo stato del sensore: facendo ruotare il verricello il contatto si deve chiudere quando il mangete passa in corrispondenza del sensore chiudendolo.</p>	<div style="border: 1px solid black; padding: 10px; text-align: center;"> <p><b>SENSOR</b></p>  </div>
<p><b>Uscita</b> Per ritornare al menù precedente.</p>	<p>Confermare con </p>

**Menù Verifiche**

<div style="border: 1px solid black; padding: 5px; margin: 10px auto; width: fit-content;"> <p><b>VERIFICHE</b></p> <p><b>TEST LCD</b></p> <p><b>SOFTWARE     1.0</b></p> <p><b>ORE FUNZ.     0</b></p> <p><b>USCITA</b></p> </div>	
<p>Utilizzare i tasti  (<b>DOWN</b>) o  (<b>UP</b>) per spostarsi tra i parametri.</p>	
<p><b>Test LCD.</b> Questa funzione accende tutti i <i>pixel</i> del <i>display</i> permettendone la verifica.</p>	<p>Selezionare con </p> <div style="border: 1px solid black; height: 100px; width: 100%; background-color: black; margin: 10px 0;"></div> <p>Confermare con </p>
<p><b>Software</b> Indica la versione del <i>software</i>.</p>	

**Ore Funz.**  
Indica le ore di funzionamento del verricello.

**Uscita**  
Per ritornare al menù di impostazione.

Confermare con 

## Calibrazione dello strumento

Prima di utilizzare lo strumento è necessario procedere all'impostazione dei seguenti parametri:

Scelta dell'**UNITA' DI MISURA** (metri o piedi) impostabile nel menu Misura

Impostazione del tipo di **SENSORE** (Standard o Elettronico) nel menù Sensore

Impostazione della circonferenza del **BARBOTIN** (in cm o pollici) nel menù Sensore: il valore da inserire è la circonferenza sul punto di avvolgimento della catena. Se il valore non è noto dalla documentazione tecnica del verricello è necessario misurare la lunghezza di catena che il barbotin può ospitare lungo tutta la sua circonferenza. Questa misura espressa in centimetri (o pollici in base all'unità di misura) è il valore che deve essere inserito nel parametro BARBOTIN

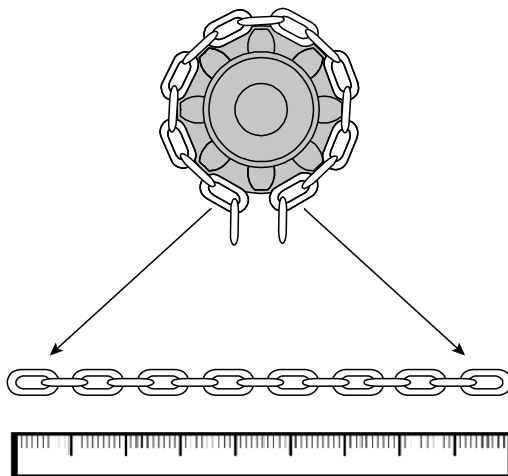

CIRCONFERENZA BARBOTIN

Impostazione del **DIVISORE** nel menù Sensore: **in caso si utilizzi un sensore standard questo valore deve essere impostato a 1** mentre se si utilizza un sensore elettronico deve essere pari al numero di impulsi del sensore per ogni giro di barbotin

## Utilizzo

Premere il tasto **(ON)** per attivare i comandi e illuminare il *display*. Lo spegnimento dell'illuminazione del *display* avviene 30 secondi dopo l'ultimo comando dato (tempo di *default* modificabile – vedi "Tempo BkLight").

Premendo il tasto **(UP)** si comanda la salita dell'ancora e con il tasto **(DOWN)** si cala l'ancora.

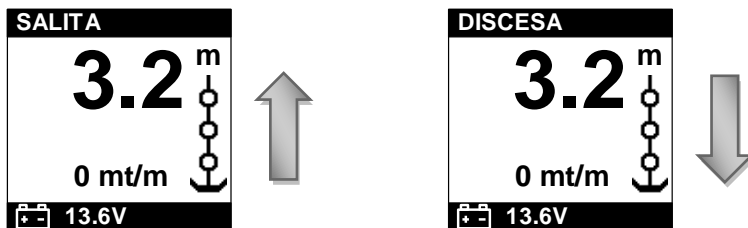

Al rilascio di ogni tasto di comando (**UP** o **DOWN**) la relativa manovra si interrompe.

## Reset della misura

Per azzerare il conteggio della misura premere il tasto **(ON)** e contemporaneamente il tasto **(UP)** per almeno tre secondi.

L'azzeramento della misura si può anche effettuare nel menù **Misura** selezionando "Si" nella riga **Azzer Misura**.



## Discesa automatica dell'ancora

Questa funzione deve essere abilitata nel menù **Allarmi e Funzioni** (di *default* la funzione è disabilitata). Selezionare la voce "**Discesa Aut.**" ed impostare il valore al quale si desidera arrestare l'ancora. Dopo che è stata impostata la quota premere il tasto **(ON)** e contemporaneamente il tasto **(DOWN)** per almeno tre secondi. Una volta avviata la discesa dell'ancora rilasciare i tasti.

**È comunque possibile, per ragioni di sicurezza, interrompere la discesa automatica premendo un tasto qualsiasi dello strumento.**

## Anomalie di funzionamento

SEGNALAZIONE	CAUSA	RIMEDIO
<b>NO SENSOR</b>	Mentre si manteneva premuto il tasto <b>UP</b> o <b>DOWN</b> lo strumento non ha ricevuto nessun segnale dal sensore magnetico per più di 5 secondi.	<p>Verificare i collegamenti elettrici del sensore.</p> <p>Verificare il funzionamento del sensore e se guasto provvedere alla sostituzione.</p> <p>Verificare la posizione del sensore, del magnete sul barbotin e la</p>

<p><b>ARRESTO</b></p> <p><b>3.2 m</b></p> <p>⚠</p> <p><b>NO SENSOR</b></p> <p> <b>13.6V</b></p>		<p>distanza tra i due (3 mm).</p> <p>Verificare il funzionamento dell'impianto elettrico o del salpa ancora stesso</p>
<p><b>TENSIONE BASSA</b></p> <p><b>TENS. BASSA</b></p> <p><b>3.2 m</b></p> <p><b>0 mt/m</b></p> <p> <b>13.6V</b></p>	<p>La tensione di alimentazione dello strumento è inferiore ai 10V.</p> <p>La segnalazione viene data solo quando lo strumento è attivo quando la retroilluminazione è accesa.</p>	<p>Verificare lo stato di carica della batteria o il funzionamento dell'impianto elettrico.</p>

## Garanzia

I nostri articoli sono garantiti contro eventuali difetti di fabbricazione per 2 anni a partire dalla data di acquisto (farà fede lo scontrino fiscale o altra prova d'acquisto). Non sono comprese nella garanzia: avarie e rotture causate dal trasporto, interventi effettuati per problemi causati da erronca installazione, avarie causate da uso improprio dell'apparecchio. La garanzia decade nell'ipotesi di manutenzione o riparazioni effettuate da persone non autorizzate dall'azienda o eseguite con l'applicazione di pezzi di ricambio non originali. La garanzia non prevede in nessun caso l'integrale sostituzione dell'apparecchio. La garanzia si riferisce esclusivamente alla sostituzione dei pezzi difettosi ed alla relativa manodopera. Non comprende il trasporto o le spese di trasferta. Il Cliente non potrà pretendere alcun rimborso per le spese sostenute.



## Description

The **HC020** chain counter displays the length of chain let out or down, expressed in metres or feet and the speed of the same.

## Technical data

Power supply	from 10 to 30 V DC
Current intake	min. 5 mA – max 60 mA
Protection rating	IP67
Operative temperature	0 / +70 °C (32 / 158 °F)
Graphic display	128 x 128 pixels
Max. chain length	999 metres – 999 feet
Size (mm)	170 x 80 x 50
Weight (g)	450*

\* with cable



**Warning**

**CONNECT ONLY TO A DC POWER SUPPLY.**

## General notes

The **HC020** chain counter must be used solely for the purposes described herein, i.e. to operate and display the number of metres/feet of chain let out by an anchor windlass or to operate a capstan. Any other use is to be considered improper.

**Any tampering with the instrument will result in immediate voiding of the warranty.**

## Components

**The package contains:**

chain counter with extensible cable and fastening kit (1 bracket with 2 screws);  
6-pole connector tap with gasket, 4 fastening screws with spacer rings and plug;  
instructions for use.

## Installation

**On a few models of anchor windlass the sensor and the magnet are already installed (chain counter setting). Therefore, the operations described below are not necessary.**

**Installing the magnet on the anchor windlass**

A hole having a diameter of 6.5 mm (~1/4") and depth of 8 mm (5/16") must be drilled on a tooth of the gipsy, in a place outside the chain's path.

In the case of vertical shaft anchor windlasses (see Fig. 1B), drill the hole in the lower circumference of the gipsy.

In the case of horizontal shaft anchor windlasses (see Fig. 2B), drill the hole in the outer circumference of the gipsy.

Also make sure that the protruding part of the magnet will not collide with the base or sensor during rotation of the gipsy.

Insert the metal part of the magnet in the hole, allowing the protected part to protrude by about 2 mm. Fix it in place using an adhesive for metals (two-component epoxy glue) or silicone. The glue used must be able to withstand a marine environment.

**Installing the magnetic sensor for vertical shaft anchor windlasses**

(see Fig. 1A – 1B)

Drill a 4 mm (~3/16") hole in the cover through which to thread the sensor cable.

Fasten Part A of the support with the two screws provided, after having positioned the O-ring in the lower part of the support.

Fit Part B with the magnetic sensor on support A and adjust its height until it is aligned with the magnet fastened on the gipsy.

Bring the sensor to a distance of about 3 mm (~1/8") from the magnet and secure it in place by tightening screw G1. Then tighten screw G2.

**Installing the magnetic sensor for horizontal shaft anchor windlasses**

(see Fig. 2A – 2B – 2C)

Drill a 4 mm (~3/16") hole in the cover through which to thread the sensor cable.

Fasten Part A of the support with the two screws provided, after having positioned the O-ring in the lower part of the support.

Cut Part C to measure using a hacksaw. The sensor must be positioned at a distance of about 3 mm (~1/8") from the magnet.

Fit Part C with the magnetic sensor on support A and fix it in place using an adhesive for plastic (two-component epoxy glue) or silicone.

Using the same glue, attach the sensor to Part C.

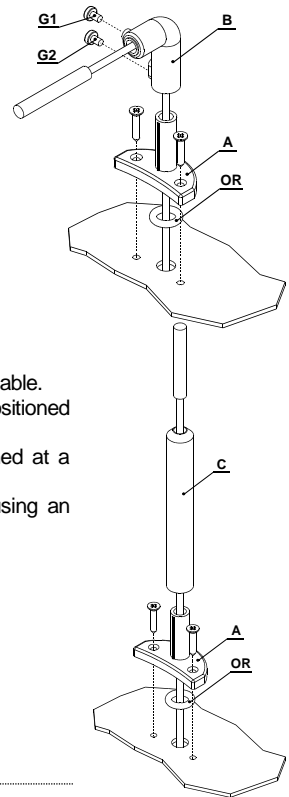

**Installing the chain counter**

(see connection diagram)



**Warning**

**ALWAYS DISCONNECT THE BATTERY PRIOR TO INSTALLATION.**

The chain counter must be positioned so that the display will be easy to read. It should not be exposed to direct sunlight.  
Secure the instrument in place with the bracket provided, tightening the two screws using a cross screwdriver.

Drill on the dashboard one hole of 20.5 mm (~13/16") and 4 holes of 2.2 mm (~3/32") to fasten the connector tap.

Put the gasket between the rear part of tap and the dashboard.

The rear part must be protected from contact with water or moisture.

For instructions on making electrical connections, see the attached diagram.

The wires must have a minimum cross section size of 1.5 mm<sup>2</sup>.

Install a 3 A (ampere) fast safety fuse on the + wire of the battery. Do not use the voltage generated by the engine battery set to provide power.

The instrument complies with EMC standards (EN55022) and must be positioned at a distance of:

- 30 cm (~1 Ft) from the compass;
- 50 cm (~1.5 Ft) from radio equipment;
- 2 metres (~6.5 Ft) from radio transmitter equipment;
- 2 metres (~6.5 Ft) from the radar beam.

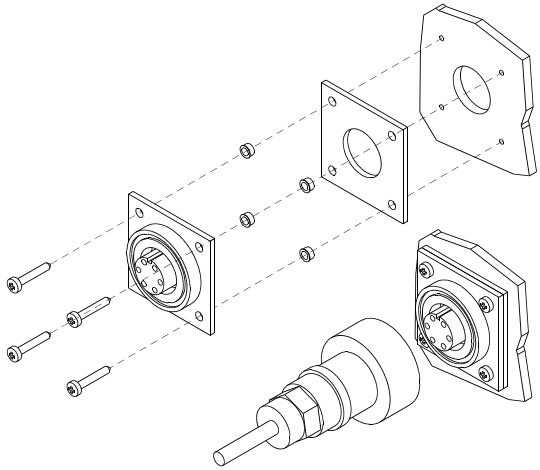

**Connections**

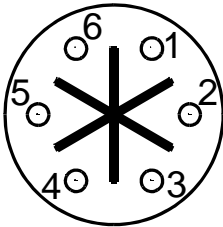

6-POLE REAR CONNECTOR	
PIN	SIGNAL
1	- battery
2	+ battery
3	DOWN command
4	UP command
5	Magnetic sensor
6	

**Connector and sensor holes**

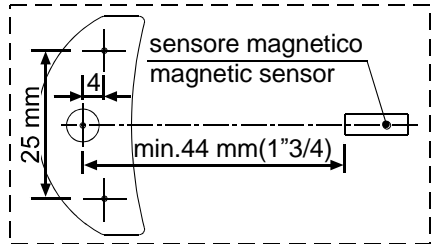
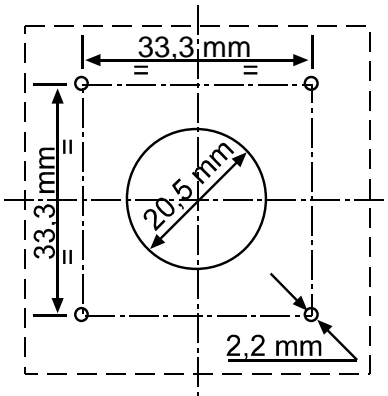

**Starting up**

The chain counter features a graphic display and three keys: **ⓘ (ON)**, **⬆ (UP)** and **⬇ (DOWN)**. The **ON** key switches on the display and enables the other two keys. It must be used to access the parameter setting menus. For selecting the parameters to be modified and to confirm the values set. The display backlight will switch off 30 seconds after the last command given (adjustable in the menu). The **UP** key commands the hoisting of the anchor and the **DOWN** key casts it. When the key is released, the action is stopped. During parameter setting, the two keys allow the User to move around the menu and vary parameter values.

When switched on, the instrument will make a beep and the following page will appear for a few seconds:



Once the initialisation procedure is complete, the main page will appear.

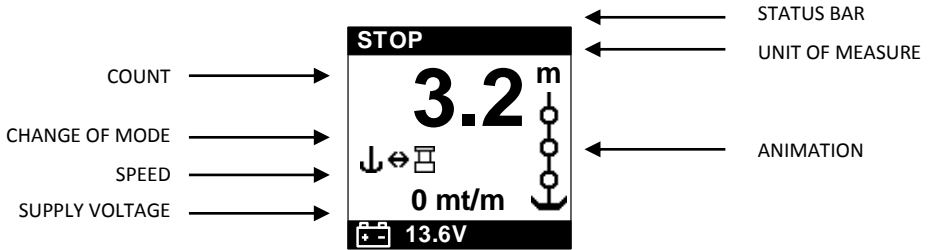

Where:

**STATUS:** indicates the status of the instrument and any failure.

**UNIT OF MEASURE:** shows the current unit of measure (metres or feet)

**ANIMATION:** an animated anchor or capstan shows the direction of the movement.

**COUNT:** indicates the measurement of the chain lowered (in metres or feet).

**CHANGE OF MODE:** this icon is displayed when there is a change in working mode (windlass mode or capstan mode)

**SPEED:** indicates the chain speed during hoisting or lowering in meters per minute (mt/m) or feet per minute (ft/m)

**SUPPLY VOLTAGE:** indicates the power supply voltage.

When the instrument is turned on for the first time, it will set up as programmed in the factory (see table).

Parameter	Default value
Up Alarm	3.0 metres
Auto Down	Off
BackLight Time	30 seconds
Units of measurement	Metres/centimetres
Chain Measure	0.0 metres
Barbotin Circumference	33 cm
Sensor type	Standard
Language	Italian
Works Hours	0
Division factor	1

**Windlass / Capstan mode**

HC020 chaincounter has two different operating modes: Windlass mode and capstan mode:

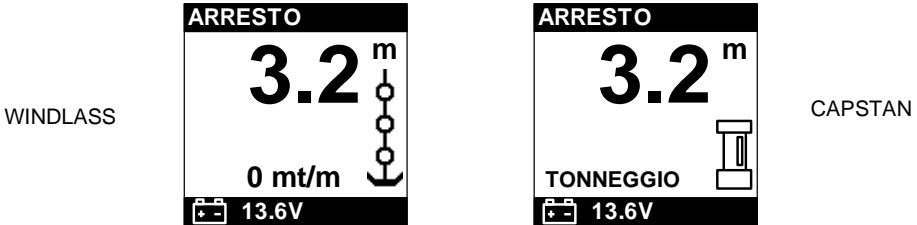

When the device is turned on it is set in windlass mode, which is standard operating mode by default: it is possible to operate the windlass obtaining lowered chain meters, chain speed and sensor error in case of faults on the sensor installed on the windlass.

In capstan mode, capstan is put in motion for standard mooring operation, without sensor reading; this way, the chain length doesn't change, chain speed is not displayed, and no sensor signal is given as it is not used when the chain is not in motion.

In order to shift from one mode to the other one, you need to press the button **Ⓢ** (**ON**) for about 3 seconds to make the icon change mode appear:



Release the button **Ⓢ** (**ON**) when the icon appears in order to do the mode change from windlass to capstan and vice versa.

**Chain counter setting menu**

<p>Hold down the <b>Ⓢ</b> (<b>ON</b>) key for six seconds to access the instrument setting menu. The following page will appear on the display:</p> <p>Use the <b>Ⓣ</b> (<b>DOWN</b>) and <b>Ⓤ</b> (<b>UP</b>) keys to move around the menu options.</p>	
<p>Once you are positioned on the item to be modified press the <b>Ⓢ</b> (<b>ON</b>) key to confirm your choice.</p>	
<p>Use the <b>Ⓣ</b> (<b>DOWN</b>) or <b>Ⓤ</b> (<b>UP</b>) keys to move from one parameter to another.</p>	
<p>Once one is positioned on the parameter press the <b>Ⓢ</b> (<b>ON</b>) key to enable modification.</p>	

According to the type of parameter, using the **⏴ (DOWN)** and **⏵ (UP)** keys it is possible to reduce/increase the value of the same or disable/enable the function.

Once the modification has been performed, press the **⏺ (ON)** key to confirm.

Using the **⏴ (DOWN)** key go to the **Exit** option and press the **⏺ (ON)** key again to return to the setting menu. The same procedure must be used to return to the main page.

**Working mode menu**

<table border="1"> <tr><th colspan="2">WORKING MODE</th></tr> <tr><th>MODE</th><th>CAP</th></tr> <tr><td>EXIT</td><td></td></tr> </table>		WORKING MODE		MODE	CAP	EXIT	
WORKING MODE							
MODE	CAP						
EXIT							
Use the <b>⏴ (DOWN)</b> or <b>⏵ (UP)</b> key to move around the parameters.							
<p><b>Mode</b> Selects the working mode:</p> <ul style="list-style-type: none"> <li>• Windlass (WND)</li> <li>• Capstan (CAP)</li> </ul>	<p>Select with <b>⏺</b> Change with <b>⏴</b> <b>⏵</b> Confirm with <b>⏺</b></p>						
<p><b>Exit</b> To return to the previous menu</p>	<p>Confirm with <b>⏺</b></p>						

**Measurement menu**

<table border="1"> <tr><th colspan="2">MEASURE</th></tr> <tr><th>RESET M.</th><th></th></tr> <tr><th>UNITS</th><th>MET</th></tr> <tr><td>EXIT</td><td></td></tr> </table>		MEASURE		RESET M.		UNITS	MET	EXIT	
MEASURE									
RESET M.									
UNITS	MET								
EXIT									
Use the <b>⏴ (DOWN)</b> or <b>⏵ (UP)</b> key to move around the parameters.									

<p><b>Reset Measurement</b> Resets the chain measurement value (0.0).</p>	<p>Select with <math>\text{⏏}</math>  <math>\text{⏴}</math> = Yes <math>\text{⏵}</math> = No          Confirm with <math>\text{⏏}</math></p>
<p><b>Units</b> Selects the unit of measurement:          Feet/ inches          Metres / centimetres</p>	<p>Select with <math>\text{⏏}</math>  <math>\text{⏴}</math> = Feet <math>\text{⏵}</math> = Metres          Confirm with <math>\text{⏏}</math></p>
<p><b>Exit</b> To return to the settings menu.</p>	<p>Confirm with <math>\text{⏏}</math></p>



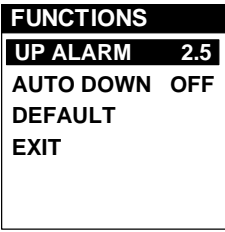







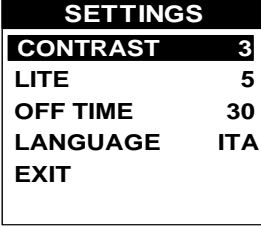









**Functions menu**

	
<p>Use the <math>\text{⏴}</math> (<b>DOWN</b>) or <math>\text{⏵}</math> (<b>UP</b>) key to move around the parameters.</p>	
<p><b>Up Alarm</b> It is possible to enable the function and establish the height at which the anchor-winch stops; after which it is only possible to give pulsed commands. Settable values: OFF, 0.5 – 1.0 – 1.5 – 2.0 – 2.5 - ... 10.0 (metres or feet).</p>	<p>Select with <math>\text{⏏}</math>          Select value with <math>\text{⏴}</math> <math>\text{⏵}</math>          Confirm with <math>\text{⏏}</math></p>
<p><b>Auto Down</b> Enables the automatic anchor lowering procedure, at the desired height, with the pressing (for at least 3 seconds) of the keys <math>\text{⏏}</math> and <math>\text{⏴}</math>. Settable value: OFF, 1,2,3...25 (metres or feet).</p>	<p>Select with <math>\text{⏏}</math>          Select value with <math>\text{⏴}</math> <math>\text{⏵}</math>          Confirm with <math>\text{⏏}</math></p>
<p><b>Load Default</b> This function allows the User to revert to the original factory default settings, <u>thus erasing all settings memorised</u>. <b>This command must only be used in the event of programming errors.</b></p>	<p>Select with <math>\text{⏏}</math>  <math>\text{⏴}</math> = Yes <math>\text{⏵}</math> = No          Confirm with <math>\text{⏏}</math></p>



<p><b>Exit</b> To return to the previous menu.</p>	<p>Confirm with </p>
--	---

**Settings menu**

	
<p>Use the  (<b>DOWN</b>) or  (<b>UP</b>) key to move around the parameters.</p>	
<p><b>Contrast</b> By enabling this function it is possible to start the display contrast programming procedure.</p>	<p>Select with  Select value with   Confirm with </p>
<p><b>Lite</b> By enabling this function it is possible to start the display luminous intensity programming procedure.</p>	<p>Select with  Select value with   Confirm with </p>
<p><b>Off time</b> This function allows the user to set the backlight on time during which the display remains lit after the last command given (default value 30 seconds).</p>	<p>Select with  Select value with   Confirm with </p>
<p><b>Language</b> The user may select the display language: Italian, English, French, German, Spanish</p>	<p>Select with  Select value with   Confirm with </p>
<p><b>Exit</b> To return to the settings menu.</p>	<p>Confirm with </p>

**Sensor menu**

<table border="1" style="margin: auto;"> <thead> <tr> <th colspan="2">SENSOR</th> </tr> <tr> <th>SENSORE</th> <th>STD</th> </tr> </thead> <tbody> <tr> <td>BARBOTIN</td> <td>33.0</td> </tr> <tr> <td>DIVISOR</td> <td>1</td> </tr> <tr> <td>TEST</td> <td></td> </tr> <tr> <td>EXIT</td> <td></td> </tr> </tbody> </table>		SENSOR		SENSORE	STD	BARBOTIN	33.0	DIVISOR	1	TEST		EXIT	
SENSOR													
SENSORE	STD												
BARBOTIN	33.0												
DIVISOR	1												
TEST													
EXIT													
<p>Use the <math>\nabla</math> (<b>DOWN</b>) or <math>\triangle</math> (<b>UP</b>) key to move around the parameters.</p>													
<p><b>Sensor</b> This function selects the sensor type:</p> <ul style="list-style-type: none"> <li>• 2-wire standard sensor (STD)</li> <li>• 3-wire electronic sensor (HAL)</li> </ul>	<p>Select with <math>\textcircled{1}</math> Select value with <math>\triangle</math> <math>\nabla</math> Confirm with <math>\textcircled{1}</math></p>												
<p><b>Barbotin</b> The circumference of the gypsy must be entered in this row (in centimeters or inches). To enter the correct value see the paragraph "instrument calibration"</p>	<p>Select with <math>\textcircled{1}</math> Select value with <math>\triangle</math> <math>\nabla</math> Confirm with <math>\textcircled{1}</math></p>												
<p><b>Divisor</b> If the standard 2-wire electronic sensor (STD) is used, this value must be left at 1. if an electronic sensor is used it must be equal to the number of sensor pulses for each turn of the barbotin. See paragraph "Instrument calibration".</p>	<p>Select with <math>\textcircled{1}</math> Select value with <math>\triangle</math> <math>\nabla</math> Confirm with <math>\textcircled{1}</math></p>												
<p><b>Test</b> This function allows you to check the correct operation of the tachometer sensor: a screen with the status of the sensor is displayed: by rotating the winch, the contact must close when the mangete passes in correspondence with the sensor, closing it.</p>	<div style="border: 1px solid black; padding: 10px; text-align: center;"> <p><b>SENSOR</b></p> </div>												
<p><b>Exit</b> To return to the previous menu.</p>	<p>Confirm with <math>\textcircled{1}</math></p>												

**Test menu**

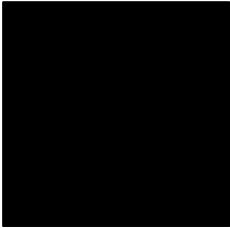
<table border="1" style="margin: auto;"> <tr><th colspan="2">TESTS</th></tr> <tr><th colspan="2">LCD TEST</th></tr> <tr><td>SOFTWARE</td><td>1.0</td></tr> <tr><td>WORK. HOUR</td><td>0</td></tr> <tr><td colspan="2">EXIT</td></tr> </table>		TESTS		LCD TEST		SOFTWARE	1.0	WORK. HOUR	0	EXIT	
TESTS											
LCD TEST											
SOFTWARE	1.0										
WORK. HOUR	0										
EXIT											
Use the ⏴ (DOWN) or ⏵ (UP) key to move around the parameters.											
<p><b>LCD Test</b> This function switches on all the display's pixels thus making it possible to perform a check on them.</p>	<p>Select with ⏴</p>  <p>Confirm with ⏴</p>										
<p><b>Software Version</b> Indicates the version of the software installed.</p>											
<p><b>Work Hours</b> Indicates the hours of operation of the winch.</p>											
<p><b>Exit</b> To return to the settings menu.</p>	<p>Confirm with ⏴</p>										

**Instrument calibration**

Before using the instrument the following parameters must be set:

- **UNIT OF MEASURE**, (metres or feet). It can be set in the Measure menu;
- **SENSOR** (2-wire standard or 3-wire electronic). It can be set in the Sensor menu;

BARBOTIN circumference setting (in cm or inches) on sensor menu: the value to be entered is the circumference on chain winding point. If this value is not available in windlass technical records, it is necessary to measure chain length which the gypsy can house on its circumference. This measure

expressed in centimeters (or inches according to the measure set) is the value which has to be entered in the Barbotin parameters

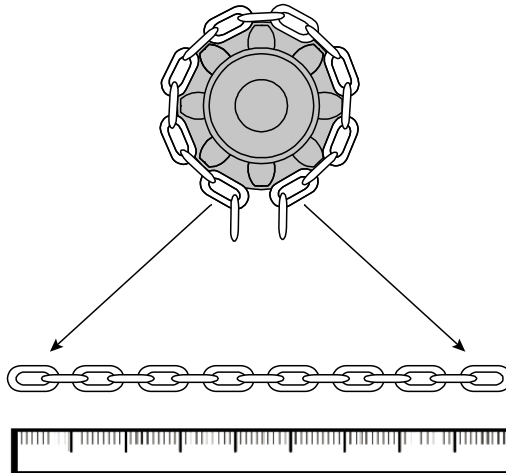

CIRCUMFERENCE OF THE BARBOTIN

Setting the **DIVIDER** in the Sensor menu: **if a standard sensor is used, this value must be set to 1** while if an electronic sensor is used it must be equal to the number of sensor pulses for each turn of the barbotin:

## Use

Press the **Ⓚ (ON)** key to activate controls and to switch on the display lighting. The *display* lighting switches off 30 seconds after the last command given (adjustable *default* time – see “BkLight Time”).

Press key **Ⓜ (UP)** to control the anchor ascending.

Press key **Ⓝ (DOWN)** to cast anchor.

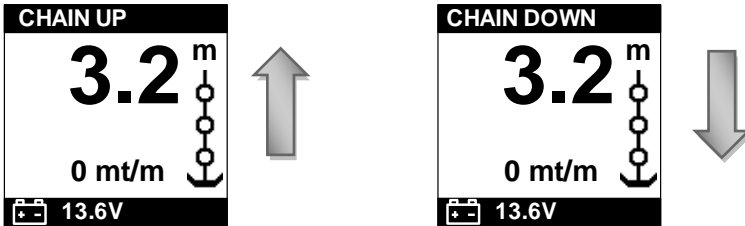

When any key is released (**UP or DOWN**) the corresponding action is stopped.

### Measurement reset

To reset the measurement count simultaneously press the **Ⓢ** (**ON**) and the **Ⓢ** (**UP**) keys for at least three seconds.

Measurement reset may also be performed in the **Measurement** menu by selecting “Yes” in the **Reset Measure** row.

### Automatic casting of the anchor

This function must be enabled in the **Alarms and Functions** menu (disabled by default).

Select the row “**Auto Down**” and set the value at which the anchor must stop. Then press the **Ⓢ** (**ON**) and **Ⓢ** (**DOWN**) keys for at least three seconds. Once anchor casting has commenced, release the keys.

**For safety reasons it is however possible to interrupt automatic descent by pressing any instrument key.**

**Troubleshooting**

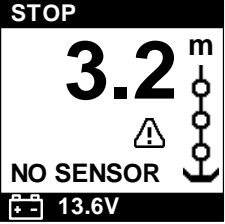
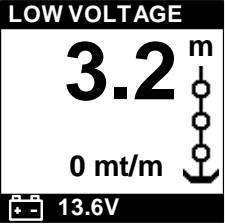
FAULT	CAUSE	CORRECTIVE ACTION
 <p>The screenshot shows a digital display with the word "STOP" at the top. Below it is a large "3.2" followed by a vertical "m" and a vertical scale icon. A warning triangle is centered below the "3.2". Underneath the triangle, it says "NO SENSOR". At the bottom left, there is a battery icon and "13.6V".</p>	<p>Though <b>UP</b> or <b>DOWN</b> keys are pressed, the instrument doesn't receive any signal from the magnetic sensor for more than 5 seconds.</p>	<p>Check the sensor electric connections.</p> <p>Check if sensor operates properly. If not, replace it.</p> <p>Check the position of sensor and magnet on gipsy and their distance (3 mm).</p> <p>Check the operation of electric installation or anchor windlass.</p>
 <p>The screenshot shows a digital display with "LOW VOLTAGE" at the top. Below it is a large "3.2" followed by a vertical "m" and a vertical scale icon. Underneath, it says "0 mt/m". At the bottom left, there is a battery icon and "13.6V".</p>	<p>The instrument's power supply voltage is lower than 10V.</p>	<p>Verify the battery charge or operation of the electrics system.</p>

**Warranty**

We guarantee our products from manufacturing defects for 2 years from the purchase date (purchase ticket or any other purchase proof will be requested). Guarantee does not include damages and breakage during the transport, damages and breakage due to faulty installation or improper use. Warranty is no longer valid when repairs or servicing have been made by unauthorized people or made with spare parts which are not original. Warranty does not include the complete replacement of the goods and refers exclusively to the replace of faulty pieces and necessary labour. It does not include transfer or transport expenses. The Customer will not ask for expenses refund.

## Description

Le compteur métrique **HC020** permet l'affichage des mètres ou pieds de chaîne enroulés ou déroulés et la vitesse des ces opérations.

## Caractéristiques techniques

Tension d'alimentation	de 10 à 30 V DC
Absorption de courant	min. 5 mA – max. 50 mA
Degré de protection	IP67
Température de fonctionnement	0°C à +70°C (32°F à 158 °F)
Moniteur graphique	128 x 128 pixels
Longueur maximum mesurable	999 mètres – 999 pieds
Dimensions (mm)	170 x 80 x 50
Poids (g)	450*

\* avec câble



**Attention**

**ALIMENTER UNIQUEMENT EN COURANT CONTINU.**

## Notes générales

Le compteur métrique **EV-020** doit être utilisé pour la fonction décrite dans le présent manuel, à savoir pour l'actionnement et la visualisation des mètres/pieds de chaîne déroulés d'un guindeau. Toute autre utilisation doit être considérée comme impropre.

**Toute modification ou opération induite sur l'instrument entraîne l'annulation immédiate de la garantie.**

## Composants

**L'emballage contient:**

compteur métrique avec câble extensible et kit de fixation (1 bride avec 2 vis);  
prise connecteur 6 pôles avec joints, 4 vis de fixation avec bagues entretoises et bouchon de fermeture;  
instructions d'utilisation.

## Installation

**Sur un nombre de modèles de guindeau le capteur et l'aimant sont déjà installés (configuration compteur métrique). Les opérations spécifiées ci-dessous ne doivent donc pas être effectuées.**

### Installation de l'aimant sur le guideau

Le trou à réaliser sur une dent du barbotin - d'un diamètre de 6,5 mm (~1/4") et d'une profondeur de 8 mm (5/16") - ne doit pas se trouver à hauteur d'une zone de passage de la chaîne.

Pour les guideaux à axe vertical (voir Fig. 1B), réaliser le trou sur la circonférence inférieure du barbotin.

Pour les guideaux à axe horizontal (voir Fig. 2B), réaliser le trou sur la circonférence externe du barbotin.

S'assurer que la partie saillante de l'aimant ne heurte pas la base ni le capteur durant la rotation du barbotin.

Introduire l'aimant dans le trou par la partie métallique en laissant dépasser d'environ 2 mm la partie protégée. Le fixer à l'aide d'une colle pour métaux (colle époxy bi-composant) ou à l'aide de silicone. La colle utilisée doit résister à l'environnement marin.

### Montage du capteur magnétique pour guideau à axe vertical

(voir Fig. 1A – 1B)

Réaliser sur le pont un trou de 4 mm de diamètre (~3/16") pour le passage du câble du capteur.

Fixer l'élément A du support à l'aide des deux vis fournies à cet effet, après avoir positionné sur la partie inférieure de ce dernier le joint torique.

Placer l'élément B, avec le capteur magnétique, sur le support A et en régler la hauteur de telle sorte qu'il soit aligné sur l'aimant fixé au barbotin.

Placer le capteur à environ 3 mm (~1/8") de l'aimant et le fixer en serrant la vis G1. Serrer ensuite la vis G2.

### Montage du capteur magnétique pour guideau à axe horizontal

(voir Fig. 2A – 2B – 2C)

Réaliser sur le pont un trou de 4 mm de diamètre (~3/16") pour le passage du câble du capteur.

Fixer l'élément A du support à l'aide des deux vis fournies à cet effet, après avoir positionné sur la partie inférieure de ce dernier le joint torique.

A l'aide d'une scie, couper l'élément C à la longueur nécessaire. Le capteur doit se trouver à environ 3 mm (~1/8") de l'aimant.

Placer l'élément C, avec le capteur magnétique, sur le support A et le fixer à l'aide d'une colle pour matériaux plastiques (colle époxy bi-composant) ou à l'aide de silicone.

A l'aide de la même colle ou de silicone, fixer le capteur à l'élément C.

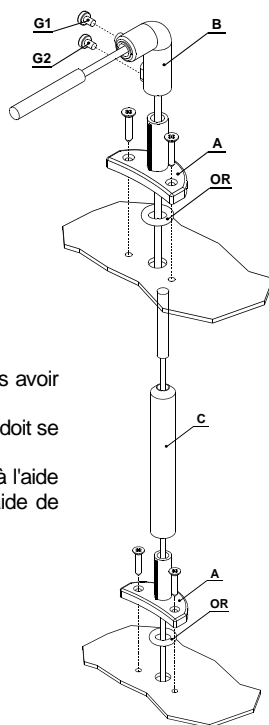

### Installation du compteur métrique

(voir schéma électrique)



**Attention**



**VEILLER À DÉBRANCHER LA BATTERIE AVANT DE PROCÉDER À L'INSTALLATION.**

Le compteur métrique doit être positionné de telle sorte que les indications affichées par le moniteur soient facilement lisibles évitant l'exposition aux rayons solaires.

Fixer l'instrument à l'aide de la bride fournie et serrer les deux vis en utilisant un tournevis cruciforme.

Réaliser sur le tableau de bord un trou de 20,5 mm (~13/16") et 4 trous de 2,2 mm (~3/32") pour fixer la prise du connecteur.

Le joint doit être placé entre la prise et le panneau du tableau de bord.

La partie postérieure doit être à l'abri de l'eau et de l'humidité.

Pour le branchement électrique, se reporter aux indications figurant sur le schéma joint en annexe. Les câbles doivent avoir une section d'au moins 1,5 mm<sup>2</sup>.

Monter un fusible de protection de 3 A (ampère) sur le câble "+" de la batterie. Pour l'alimentation, ne pas utiliser le courant provenant du groupe de batteries moteurs.

L'instrument répond aux standards EMC (EN55022) et doit se trouver à une distance d'au moins:

- 30 cm (~1 pied) de la boussole;
- 50 cm (~1,5 pieds) d'appareils radio;
- 2 mètres (~6,5 pieds) de stations émettrices;
- 2 mètres (~6,5 pieds) du faisceau radar.

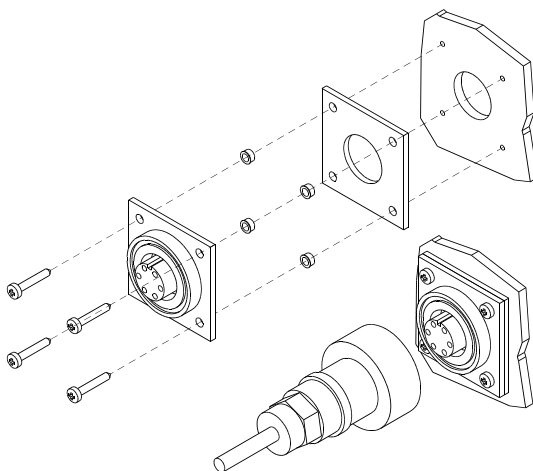

**Branchements**

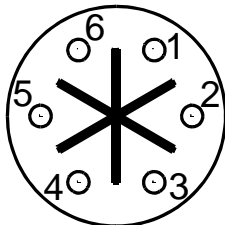

CONNECTEUR POSTÉRIEUR 6 PÔLES	
PIN	SIGNAL
1	- batterie
2	+ batterie
3	Commande DOWN
4	Commande UP
5	Capteur magnétique
6	

**Trous connecteur et capteur**

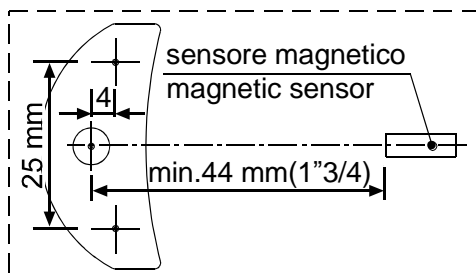
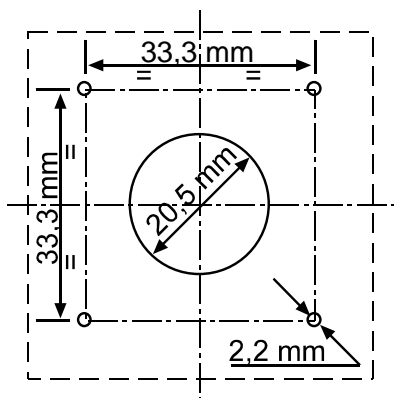

**Premier allumage**

Le compteur métrique est équipé d'un moniteur graphique et de trois touches: **ON** (ⓘ), **UP** (⬆) et **DOWN** (⬇). La touche **ON** allume le moniteur et permet d'utiliser les deux autres touches. Il est utilisé pour avoir accès aux menus de sélection des paramètres, de modification des paramètres et de confirmation des valeurs sélectionnées. L'extinction de l'éclairage du moniteur se produit 30 secondes après la dernière commande utilisée (temps par défaut modifiable – voir «Temps BkLight»).

La touche **UP** commande la remontée de l'ancre, la touche **DOWN** la descente. La manœuvre s'interrompt si la touche est relâchée. Durant la sélection des paramètres, les deux touches permettent le mouvement à l'intérieur du menu et la variation des valeurs des paramètres.

Lors de l'allumage de l'instrument on entend un beep sonore et apparaît pour quelques secondes la page suivante:



Une fois terminée la procédure d'initialisation, apparaît la page principale.

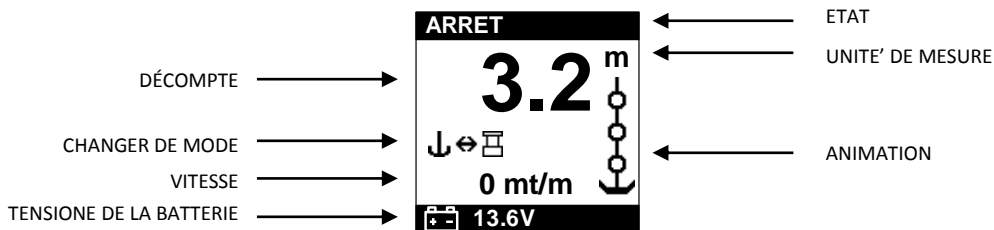

Où:

**ÉTAT:** indique l'état de l'instrument et les anomalies éventuelles.

**UNITE' DE MESURE:** mètres ou pieds

**ANIMATION:** une chaîne ou cabestan s'affiche pour indiquer le sens du mouvement

**DÉCOMPTE:** indique la longueur de la chaîne descendue (mètres ou pieds).

**CHANGER DE MODE:** cette icône apparaît lorsque vous changez le barbotin / cabestan

**VITESSE:** indique la vitesse de la chaîne, remontée ou descente, en mètres ou pieds par minute.

**TENSION DE LA BATTERIE:** la tension de la batterie qui alimente l'instrument est affichée

Lors du premier allumage, l'instrument se positionne conformément à la programmation par défaut (voir tableau).

Paramètre	Valeur par défaut
Alarme montée	3,0 mètres
Descente automatique	Off
Temps BackLight	30 secondes
Unité de mesure	Mètres/centimètres
Mesure chaîne	0,0 mètres
Circonférence du Barbotin	33 cm
Type capteur	inconnu
Langue	Italien
Heures fonctionnement	0
Facteur de division	1

## Modalité guindeau / cabestan

Le compteur de chaîne HC020 a deux différents fonctionnements: modalité guindeau et modalité cabestan.

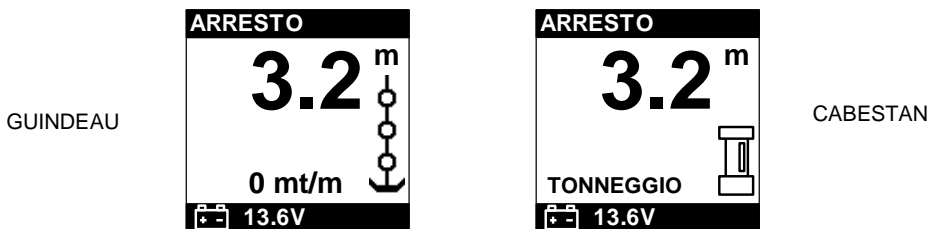

Quand l'instrument est allumé, il se positionne en modalité guindeau qui est la modalité standard de fonctionnement : il est donc possible d'actionner le guindeau en obtenant la mesure des mètres de chaîne déroulée, le calcul de la vitesse de l'ancre et éventuellement le message d'erreur en cas d'anomalie ou dommage sur le capteur compte-tours installé sur le guindeau.

Dans la modalité cabestan, le cabestan est actionné pour les opérations d'amarrage dans le port, mais sans la lecture du capteur compte-tours ; dans cette modalité la longueur de la chaîne ne change pas, la vitesse de la chaîne n'est pas visualisée et aucun signal sur l'état du capteur n'est donné, n'étant celui-ci en usage quand la chaîne est arrêtée.

Pour passer d'une modalité à l'autre, il est nécessaire d'appuyer sur la touche **(ON)** pendant 3 secondes pour faire apparaître l'icône de changement de modalité:



Quand celle-ci apparaît, relâcher la touche **(ON)** permet le changement de la modalité guindeau à la modalité cabestan et vice versa.

## Menu de programmation du compteur métrique

En maintenant enfoncée la touche **(ON)**, pendant six secondes, on a accès au menu de programmation de l'instrument. Sur le moniteur apparaît la page suivante:

Utiliser les touches **(DOWN)** et **(UP)** pour se déplacer à l'intérieur du menu.

MENU	
MODE DE FON	█
MESURES	
FONCTIONS	
PARAMETRES	
CAPTEUR	
CAN	

Se porter sur la rubrique à modifier et appuyer sur la touche **(ON)** pour valider le choix.

Utiliser les touches $\nabla$ ( <b>DOWN</b> ) ou $\triangle$ ( <b>UP</b> ) pour se déplacer parmi les paramètres.
Une fois choisi le paramètre appuyer sur la touche $\text{ON}$ pour activer la modification.
En fonction du type de paramètre, utiliser les touches $\nabla$ ( <b>DOWN</b> ) et $\triangle$ ( <b>UP</b> ), pour réduire/augmenter la valeur ou désactiver/activer la fonction.
Une fois la modification effectuée, appuyer sur la touche $\text{ON}$ pour valider.
Au moyen de la touche $\nabla$ ( <b>DOWN</b> ) se porter sur la rubrique <b>Quitter</b> et appuyer de nouveau sur la touche $\text{ON}$ pour retourner au menu programmation. Suivre la même procédure pour retourner à la page principale.

### Menu Mode de fonctionnement

<table border="1" style="margin: auto;"> <tr><th colspan="2">MODE DE FON</th></tr> <tr><th>MODE</th><th>CAP</th></tr> <tr><td colspan="2">QUITTER</td></tr> </table>		MODE DE FON		MODE	CAP	QUITTER	
MODE DE FON							
MODE	CAP						
QUITTER							
Utiliser les touches $\nabla$ ( <b>DOWN</b> ) ou $\triangle$ ( <b>UP</b> ) pour se déplacer parmi les paramètres.							
<b>Mode</b> sélectionner le mode de fonctionnement <ul style="list-style-type: none"> <li>• Barbotin (WND)</li> <li>• Capstan (CAP)</li> </ul>	Sélectionner avec $\text{ON}$ $\nabla$ = Oui $\triangle$ = Non Valider avec $\text{ON}$						
<b>Quitter</b> Pour revenir au menu.	Valider avec $\text{ON}$						

**Menu mesure**

<table border="1" style="margin: auto;"> <tr><th colspan="2">MEASURE</th></tr> <tr><th colspan="2">ZEROT M.</th></tr> <tr><td>UNITE M.</td><td>MET</td></tr> <tr><td colspan="2">QUITTER</td></tr> </table>		MEASURE		ZEROT M.		UNITE M.	MET	QUITTER	
MEASURE									
ZEROT M.									
UNITE M.	MET								
QUITTER									
Utiliser les touches $\nabla$ (DOWN) ou $\triangle$ (UP) pour se déplacer parmi les paramètres.									
<b>Zerot.mesure</b> Remet à zéro la longueur de la chaîne (0.0).	Sélectionner avec $\text{Ⓢ}$ $\nabla$ = Oui $\triangle$ = Non Valider avec $\text{Ⓢ}$								
<b>Unité de mesure</b> Sélectionne l'unité de mesure: Pieds / pouces Mètres /centimètres	Sélectionner avec $\text{Ⓢ}$ $\triangle$ = Pieds $\nabla$ = Mètres Valider avec $\text{Ⓢ}$								
<b>Quitter</b> Pour revenir au menu de programmation.	Valider avec $\text{Ⓢ}$								

**Menu fonctions**

<table border="1" style="margin: auto;"> <tr><th colspan="2">FONCTIONS</th></tr> <tr><th colspan="2">AL. MONTEE 2.5</th></tr> <tr><td>DESCENTE</td><td>OFF</td></tr> <tr><td colspan="2">INFO FABR</td></tr> <tr><td colspan="2">QUITTER</td></tr> </table>		FONCTIONS		AL. MONTEE 2.5		DESCENTE	OFF	INFO FABR		QUITTER	
FONCTIONS											
AL. MONTEE 2.5											
DESCENTE	OFF										
INFO FABR											
QUITTER											
Utiliser les touches $\nabla$ (DOWN) ou $\triangle$ (UP) pour se déplacer parmi les paramètres.											
<b>Alarme montée</b> On peut activer la fonction et établir la hauteur d'arrêt du guindeau. Après, seule la commande par impulsions est possible.	Sélectionner avec $\text{Ⓢ}$ Sélectionner la valeur au moyen de $\triangle$ $\nabla$										

Valeur programmable. OFF, 0,5 – 1.0 – 1.5 – 2.0 – 2.5 –...10.0 (mètres ou pieds).	Valider avec Ⓚ
<b>Descente automatique</b> Active la procédure de descente automatique de l'ancre à la longueur désirée, par la pression (au moins 3 sec.) des touches Ⓚ et Ⓛ. Valeur programmable. OFF, 1,2,3...25 (mètres ou pieds).	Sélectionner avec Ⓚ Sélectionner la valeur au moyen de Ⓛ Ⓧ Valider avec Ⓚ
<b>Info fabriquer</b> Cette fonction permet de rappeler les données d'origine par défaut, en <u>effaçant les données mémorisées.</u> <b>Utiliser cette commande uniquement en cas d'erreur de programmation.</b>	Sélectionner avec Ⓚ Ⓧ = Oui Ⓛ = Non Valider avec Ⓚ
<b>Quitter</b> Pour revenir au menu de programmation.	Valider avec Ⓚ

**Menu programmations**



<table border="1" style="margin: auto;"> <tr> <th colspan="2">PARAMETRES</th> </tr> <tr> <td><b>CONTRASTE</b></td> <td><b>3</b></td> </tr> <tr> <td><b>ECLAIRAGE</b></td> <td><b>5</b></td> </tr> <tr> <td><b>TEMPS EX.</b></td> <td><b>30</b></td> </tr> <tr> <td><b>LANGUE</b></td> <td><b>ITA</b></td> </tr> <tr> <td><b>QUITTER</b></td> <td></td> </tr> </table>		PARAMETRES		<b>CONTRASTE</b>	<b>3</b>	<b>ECLAIRAGE</b>	<b>5</b>	<b>TEMPS EX.</b>	<b>30</b>	<b>LANGUE</b>	<b>ITA</b>	<b>QUITTER</b>	
PARAMETRES													
<b>CONTRASTE</b>	<b>3</b>												
<b>ECLAIRAGE</b>	<b>5</b>												
<b>TEMPS EX.</b>	<b>30</b>												
<b>LANGUE</b>	<b>ITA</b>												
<b>QUITTER</b>													
Utiliser les touches Ⓧ (DOWN) ou Ⓛ (UP) pour se déplacer parmi les paramètres.													
<b>Contraste</b> Cette fonction permet d'activer la procédure de sélection du contraste du moniteur.	Sélectionner avec Ⓚ Sélectionner la valeur au moyen de Ⓛ Ⓧ Valider avec Ⓚ												
<b>Eclairage</b> Cette fonction permet d'activer la procédure de sélection de l'intensité de la lumière du moniteur.	Sélectionner avec Ⓚ Sélectionner la valeur au moyen de Ⓛ Ⓧ Valider avec Ⓚ												
<b>Temps BackLight</b> Cette fonction permet de programmer le temps d'éclairage du moniteur après la dernière commande utilisée (valeur par	Sélectionner avec Ⓚ Sélectionner la valeur au moyen de Ⓛ Ⓧ Valider avec Ⓚ												

défaut 30 secondes).	
<b>Langue</b> On peut sélectionner la langue du moniteur: Italien, Anglais, Français, Allemand Espagnol	Sélectionner avec Ⓚ Sélectionner la valeur au moyen de ⏴ ⏵ Valider avec Ⓚ
<b>Quitter</b> Pour revenir au menu	Valider avec Ⓚ



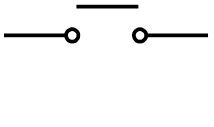

### Menu capteur

<table border="1" style="margin: auto;"> <thead> <tr> <th colspan="2">CAPTEUR</th> </tr> <tr> <th>CAPTEUR</th> <th>STD</th> </tr> </thead> <tbody> <tr> <td>BARBOTIN</td> <td>33.0</td> </tr> <tr> <td>DIVISEUR</td> <td>1</td> </tr> <tr> <td>TEST</td> <td></td> </tr> <tr> <td>QUITTER</td> <td></td> </tr> </tbody> </table>		CAPTEUR		CAPTEUR	STD	BARBOTIN	33.0	DIVISEUR	1	TEST		QUITTER	
CAPTEUR													
CAPTEUR	STD												
BARBOTIN	33.0												
DIVISEUR	1												
TEST													
QUITTER													
Utiliser les touches ⏴ ( <b>DOWN</b> ) ou ⏵ ( <b>UP</b> ) pour se déplacer parmi les paramètres.													
<b>Capteur</b> Vous permet de définir le type de capteur: <ul style="list-style-type: none"> <li>• Standard ou 2 fils (STD)</li> <li>• Électronique ou 3 fils (HAL)</li> </ul>	Sélectionner avec Ⓚ Sélectionner la valeur au moyen de ⏴ ⏵ Valider avec Ⓚ												
<b>Circonférence du Barbotin</b> Sur cette ligne il faut inscrire la circonférence du Barbotin (centimètres ou pouces).	Sélectionner avec Ⓚ Sélectionner la valeur au moyen de ⏴ ⏵ Valider avec Ⓚ												
<b>Diviseur</b> Si le capteur électronique standard à 2 fils (STD) est utilisé, cette valeur doit être laissée à 1. si un capteur électronique est utilisé, il doit être égal au nombre d'impulsions du capteur pour chaque tour de barbotin. Voir paragraphe "Calibrage de l'instrument".	Sélectionner avec Ⓚ Sélectionner la valeur au moyen de ⏴ ⏵ Valider avec Ⓚ												



<p><b>Verif. LCD</b> Cette fonction allume tous les pixel du moniteur et permet d'effectuer son contrôle.</p>	<div style="border: 1px solid black; padding: 10px; text-align: center;"> <p><b>SENSOR</b></p>  </div>
<p><b>Quitter</b> Pour revenir au menu de programmation.</p>	<p>Valider avec </p>

**Menu Contrôles**

<div style="border: 1px solid black; padding: 5px; text-align: center;"> <p><b>CONTROLES</b></p> <div style="border: 1px solid black; padding: 2px; display: inline-block;"> <p><b>LCD TEST</b></p> <p><b>SOFTWARE    1.0</b></p> <p><b>HEURES F.    0</b></p> <p><b>QUITTER</b></p> </div> </div>	
<p>Utiliser les touches  (<b>DOWN</b>) ou  (<b>UP</b>) pour se déplacer parmi les paramètres.</p>	
<p><b>Verif. LCD</b> Cette fonction allume tous les pixel du moniteur et permet d'effectuer son contrôle.</p>	<p>Sélectionner avec </p> <div style="border: 1px solid black; width: 100%; height: 100%; background-color: black; margin: 10px 0;"></div> <p>Valider avec </p>
<p><b>Version Software</b> Indique la version du logiciel.</p>	

**Heures fonctionnement**

Indique les heures de fonctionnement du treuil.

**Quitter**

Pour revenir au menu de programmation.

Valider avec 

**Calibrage de l'instrument**

Avant d'utiliser l'instrument il faut programmer les paramètres suivants:

choix de **l'unité de mesure** (mètres ou pieds);

choix de **type de capteur** (Standard ou Project);

Pour établir la circonférence du **BARBOTIN** (en cm ou pouces) dans le menu Capteur: La valeur à introduire est la circonférence sur le point d'enroulement de la chaîne. Si la valeur est inconnue, il est nécessaire de mesurer la longueur de la chaîne que le barbotin peut supporter le long de sa circonférence. Cette mesure en centimètres (ou pouces selon l'unité de mesure) est la valeur qui doit être introduite dans le paramètre BARBOTIN

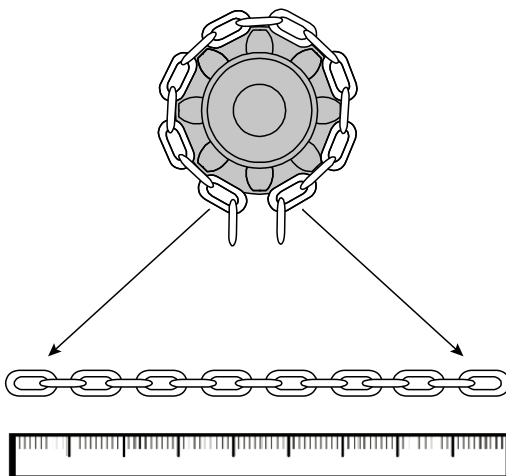

CIRCONFERENZA BARBOTIN

Réglage du DIVISEUR dans le menu Capteur: si un capteur standard est utilisé, cette valeur doit être mise à 1 tandis que si un capteur électronique est utilisé, il doit être égal au nombre d'impulsions du capteur pour chaque tour du barbotin

## Utilisation

Appuyer sur la touche **Ⓢ** (**ON**) pour activer les commandes et éclairer le moniteur. L'extinction de l'éclairage du moniteur se produit 30 secondes après la dernière commande utilisée (temps par défaut modifiable – voir «Temps BkLight»).

En appuyant sur la touche **Ⓢ** (**UP**) on commande la remontée de l'ancre.

En appuyant sur la **Ⓡ** (**DOWN**) on jette l'ancre.



En relâchant la touche de commande (**UP** ou **DOWN**), la manœuvre correspondante est interrompue.

## Remise à zéro de la longueur

Pour remettre à zéro le calcul de la longueur, appuyer sur la touche **Ⓢ** (**ON**) et en même temps sur la touche **Ⓢ** (**UP**) pendant au moins trois secondes.

La remise à zéro de la longueur peut être effectuée à partir du menu **Longueur** en sélectionnant «**Oui**» sur la ligne **Zerot.mesure**.

## Décence automatique de l'ancre

Cette fonction doit être activée sur le menu **Alarmes et Fonctions** (la fonction est désactivée par défaut).

Sélectionner la fonction «**Descente aut.**» et sélectionner la hauteur à laquelle l'ancre doit s'arrêter. Après, appuyer sur la touche **Ⓢ** (**ON**) et en même temps sur la touche **Ⓡ** (**DOWN**) pendant au moins trois secondes. Une fois commencée la descente de l'ancre relâcher les touches.

**Pour des raisons de sécurité il est possible d'arrêter automatiquement à tout moment la descente en appuyant sur n'importe quelle touche.**

**Anomalies de fonctionnement**

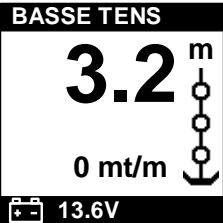
SYMPTÔME	CAUSE	INTERVENTION
	<p>Alors que la touche <b>UP</b> ou <b>DOWN</b> est enfoncée, l'instrument ne reçoit aucun signal du capteur magnétique pendant plus de 5 secondes.</p>	<p>Vérifier les branchements électriques du capteur</p> <p>Vérifier le fonctionnement du capteur. S'il est abîmé, le remplacer.</p> <p>Vérifier la position du capteur et de l'aimant sur le barbotin et la distance entre les deux (3 mm).</p> <p>Vérifier le fonctionnement de l'installation électrique ou du guindeau.</p>
	<p>La tension d'alimentation de l'instrument est inférieure à 10V.</p>	<p>Vérifier l'état de charge de la batterie ou le fonctionnement de l'installation électrique.</p>

**Garantie**

Nos produits sont certifiés contre les éventuels défauts de fabrication pendant deux ans à partir de la date d'achat (le ticket de caisse ou autre preuve d'achat feront foi). La garantie ne comprend pas: pannes et ruptures causées par le transport, interventions effectuées dues à mauvaise installation, pannes causées par emploi erroné de l'appareil. La garantie n'est pas valide en cas d'entretien ou réparation effectuées par des personnes qui ne sont pas autorisées, ou bien avec des rechanges qui ne sont pas originaux. La garantie ne prévoit pas en aucun cas le remplacement total de l'appareil; elle ne concerne que les pièces défectueuses et la manoeuvre. Elle ne comprend non plus les frais de transport et les éventuels frais de déplacement. Le Client ne pourra demander aucun remboursement des frais payées.

## Beschreibung

Der Meterzähler **HC020** erlaubt, einen Anker mit der Anzeige in Metern oder Fuß der abgewickelten Kettenlänge und der Geschwindigkeit zu lichten oder auszuwerfen.

## Technische Merkmale

Anschlussspannung	von 10 bis 30 V DC
Stromaufnahme	min. 5 mA – max 50 mA
Schutzgrad	IP67
Betriebstemperatur	0 / +70 °C (32 / 158 °F)
Graphisches <i>Display</i>	128 x 128 pixels
Max. erreichbares Maß	999 Meter – 999 Fuß
Abmessungen (mm)	170 x 80 x 50
Gewicht (g)	450*

\* mit Kabel



**Achtung**

**AUSSCHLIESSLICH AN GLEICHSTROM ANSCHLIESSEN.**

## Allgemeine Hinweise

Der Meterzähler **EV-020** darf nur für die in diesem Handbuch beschriebenen Zwecke verwendet werden: Antrieb und Anzeige von Metern/Fuß einer von einem Ankerspill abgewickelten Kette. Jeder andere Gebrauch ist unzulässig.

**Mutwillige Änderungen am Instrument führen zum sofortigen Verfall der Garantie.**

## Komponenten

### Die Packung enthält:

Meterzähler mit ausziehbarem Kabel und Befestigungssatz (1 Bügel mit 2 Schrauben);  
6 poliger Steckdose mit Dichtung, 4 Befestigungsschrauben mit Distanzringen und Deckel;  
Gebrauchsanweisung.

## Installation

**Bei einigen Ankerspillmodellen sind Sensor und Magnet bereits installiert (Einrichtung für Meterzähler), deshalb müssen die nachstehenden Arbeitsgänge nicht ausgeführt werden.**

### Installation des Magneten im Ankerspill

Das Bohrloch an einem Zahn der Kettennuss - Durchmesser 6,5 mm (~1/4") und Tiefe 8 mm (5/16") – muss an einer Stelle gebohrt werden, an der die Kette nicht durchläuft.

Für das Ankerspill mit Vertikalachse (siehe Fig. 1B) muss die Bohrung im unteren Kreis der Kettennuss gebohrt werden.

Für das Ankerspill mit Horizontalachse (siehe Fig. 2B) muss die Bohrung im äußeren Kreis der Kettennuss gebohrt werden.

Es muss zudem überprüft werden, dass der hervorragende Teil des Magneten während der Drehung der Kettennuss die Unterlage oder den Sensor nicht berührt.

Den Magneten mit dem Metallteil in das Bohrloch einsetzen und den geschützten Teil ca. 2 mm vorstehen lassen. Mit einem Metallkleber (Zweikomponenten-Epoxydkleber) oder Silikon befestigen. Der Kleber muss salzwasserbeständig sein.

### Montage des Magnetsensors für Ankerspill mit Vertikalachse

(siehe Fig. 1A – 1B)

Ein Loch mit 4 mm (~3/16") Durchmesser als Kabeldurchgang für den Sensor in das Deck bohren.

Den O-Ring in den unteren Teil des Teils A der Halterung einsetzen und diese mit den zwei mitgelieferten Schrauben festschrauben.

Das Teil B mit dem Magnetsensor auf die Halterung A montieren und in der Höhe so einstellen, dass dieser sich auf gleicher Achse wie der Magnet auf der Kettennuss befindet.

Den Sensor bis ca. 3 mm (~1/8") an den Magnet annähern und mit der Schraube G1 festschrauben. Danach die Schraube G2 anziehen.

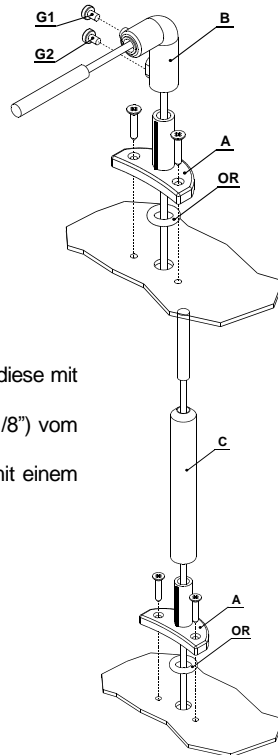

### Montage des Magnetsensors für Ankerspill mit

#### Horizontalachse

(siehe Fig. 2A – 2B – 2C)

Ein Loch mit 4 mm (~3/16") Durchmesser als Kabeldurchgang für den Sensor in das Deck bohren.

Den O-Ring in den unteren Teil des Teils A der Halterung einsetzen und diese mit den zwei mitgelieferten Schrauben festschrauben.

Das Teil C mit einer Säge zuschneiden. Der Sensor muss ca. 3 mm (~1/8") vom Magnet entfernt positioniert werden.

Das Teil C mit dem Magnetsensor auf die Halterung A montieren und mit einem Metallkleber (Zweikomponenten-Epoxydkleber) oder Silikon befestigen.

Mit dem gleichen Kleber den Sensor an das Teil C befestigen.

### Installation des Meterzählers

(siehe Stromlaufplan)



**Achtung**

**VOR DER INSTALLATION DIE BATTERIE IMMER ABKLEMMEN.**

Der Meterzähler muss so positioniert sein, dass das Display gut ablesbar und nicht dem Sonnenlicht ausgesetzt ist.

Das Instrument mit dem mitgelieferten Bügel und den zwei Schrauben mit einem Kreuzschraubenzieher festschrauben.

Ein Loch mit 20,5 mm (~13/16") und 4 Löcher mit 2,2 mm (~3/32") für die Befestigung der Steckdose bohren.

Die Dichtung muss zwischen die Steckdose und das Deck eingelegt werden.

Die Rückseite muss vor Wasser und Feuchtigkeit geschützt sein.

Für den Stromanschluss sind die Anweisungen des beiliegenden Stromlaufplans zu befolgen. Die Kabel müssen einen Mindestquerschnitt von 1,5 mm<sup>2</sup> aufweisen.

Eine flinke 3 A (Ampere) Sicherung auf das Kabel + der Batterie montieren. Für die Stromzufuhr nicht die Spannung von den Motorbatterien verwenden.

Das Instrument entspricht den EMC-Standards (EN55022) und muss mindestens:

- 30 cm (~1 Ft) vom Kompass,
- 50 cm (~1,5 Ft) von Funkempfängern,
- 2 Meter (~6,5 Ft) von Funksendern,
- 2 Meter (~6,5 Ft) vom Radarstrahl.

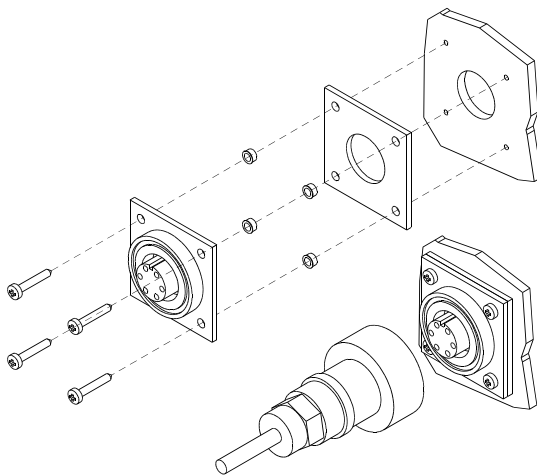

## Anschlüsse

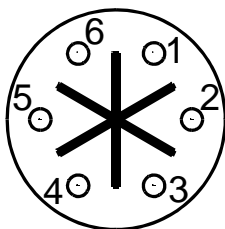

HINTERE 6 POLIGE STECKVERBINDUNG	
PIN	SIGNAL
1	- batterie
2	+ batterie
3	Steuerung DOWN
4	Steuerung UP
5	Magnetsensor
6	

## Bohr Steckverbinder und Sensor

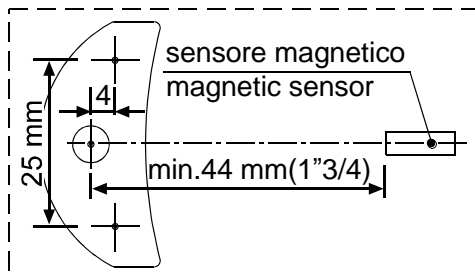
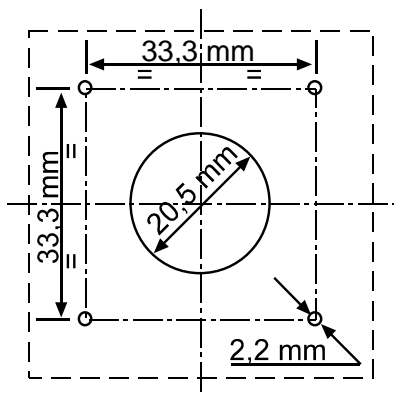

## Werkseinstellung des Instruments

Der Meterzähler ist mit einem graphischen *Display* und drei Tasten ausgerüstet: **ON** (ⓘ), **UP** (⬆) und **DOWN** (⬇).

Die Taste **ON** schaltet das *Display* ein und die anderen beiden Tasten frei. Sie wird für den Zugriff zu den Eingabemenüs der Parameter, die Auswahl der zu ändernden Parameter und die Bestätigung der Eingabewerte verwendet. Die Beleuchtung des *Displays* schaltet 30 Sekunden nach dem letzten Steuerbefehl aus (änderbare *Default-Zeit* – siehe "Zeit BkLight").

Die Taste **UP** steuert das Licht des Ankers und die Taste **DOWN** das Auswerfen. Sobald die Taste losgelassen wird, stoppt die entsprechende Bewegung. In der Parametereingabephase kann das Menü mit den beiden Tasten durchlaufen und die Änderung der Parameterwerte vorgenommen werden.

Beim Einschalten des Instruments ertönt ein akustisches Signal und ein paar Sekunden lang erscheint die folgende Seite:





Nach Beendigung der Initialisierung erscheint die Hauptseite.

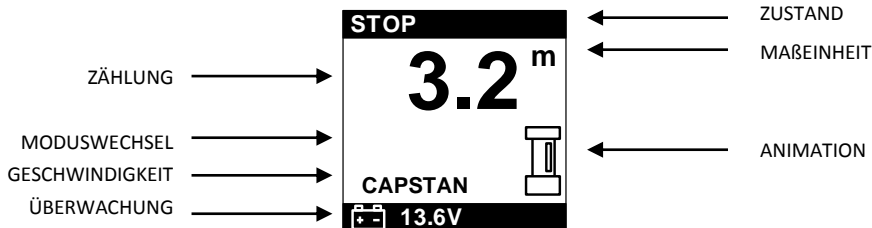

Mit folgenden Angaben:

**ZUSTAND:** Zustand es Instruments und eventuelle Störungen.

**GESCHWINDIGKEIT:** Kettengeschwindigkeit in beiden Richtungen, in Metern oder Fuß pro Minute.

**ZÄHLUNG:** Länge der ausgeworfenen Kette (Metern oder Fuß).

**ÜBERWACHUNG:** Anschlussspannung.

**MAßEINHEIT:** Meter oder Fuß

**ANIMATION:** Eine Kette oder ein Warp wird angezeigt, um die Bewegungsrichtung anzuzeigen

**MODUSWECHSEL:** Dieses Symbol wird angezeigt, wenn Sie den Winden- / Warp-Modus ändern

Beim erstmaligen Einschalten stellt sich das Instrument auf die Werkseinstellungen ein (siehe Tabelle).

Parameter	Defaulteinstellung
Fierenalarm	3.0 Meter
Automatisches Abstieg	Off
BackLight Zeit	30 Sekunden
Maßeinheit	Meter / Zentimeter
Kettenmaß	0.0 Meter
Kettenusskreis	33 cm
Typ sensor	unbekannt
Sprache	Italienisch
Betriebszeit	0
Teilungsfaktor	1

## Winden / Warpen modus

Der HC020-Zähler verfügt über zwei verschiedene Betriebsarten: Windenmodus und Warp-Modus.

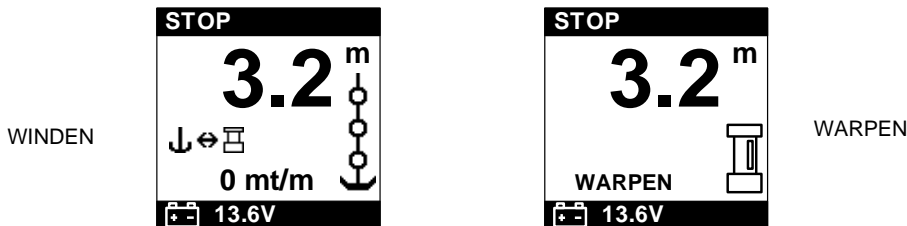

Wenn das Instrument eingeschaltet ist, positioniert es sich im Windenmodus, der daher der Standardbetriebsmodus ist: Es ist möglich, die Winde zu bedienen, wobei die Messung der abgesehenen Kettenmeter, die Berechnung der Ankergeschwindigkeit und möglicherweise das Sensorfehlersignal bei Anomalien erhalten werden oder Fehler am Drehzahlsensor, der an Bord der Winde installiert ist.

Im Festmachermodus wird der Festmacher hingegen für normale Andockvorgänge im Hafen aktiviert, ohne jedoch den Drehzahlzählersensor zu lesen. In diesem Modus ändert sich daher die Länge der Kette nicht, die Geschwindigkeit der Kette wird nicht angezeigt und es wird kein Signal zum Status des Sensors gegeben, der nicht tatsächlich verwendet wird, da die Kette stationär ist.

Um von einem Modus in einen anderen zu wechseln, drücken Sie die Taste (EIN) 3 Sekunden lang, um das Symbol für den Moduswechsel aufzurufen:



Wenn es erscheint, lassen Sie die Taste los (EIN) wechselt von Winde zu Festmachen oder umgekehrt.

## Einstellmenü des Meterzählers

Die Taste **Ⓜ** (**ON**) für den Zugriff zum Einstellmenü des Instruments sechs Sekunden lang drücken. Auf dem *Display* erscheint folgende Seite:

Mit der Taste **⏴** (**DOWN**) und **⏵** (**UP**) zu den verschiedenen Menüpositionen springen.

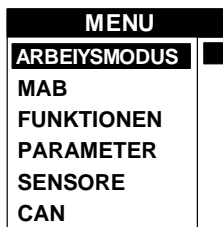

Wenn die zu ändernde Position erreicht ist, die Taste **Ⓜ** (**ON**) zur Bestätigung der Auswahl drücken.











Mit den Tasten **⏴** (**DOWN**) oder **⏵** (**UP**) zu den verschiedenen Parametern springen.

Wenn der gewünschte Parameter erreicht ist, die Taste <b>Ⓜ</b> ( <b>ON</b> ) zur Freischaltung der Änderung drücken.
Je nach Art des Parameter die Taste <b>Ⓣ</b> ( <b>DOWN</b> ) und <b>Ⓤ</b> ( <b>UP</b> ) benutzen und den Wert nach oben/unten ändern oder die Funktion aus-/freischalten.
Wenn die Änderung ausgeführt ist, mit der Taste <b>Ⓜ</b> ( <b>ON</b> ) bestätigen.
Mit der Taste <b>Ⓣ</b> ( <b>DOWN</b> ) auf die Position <b>Ausgang</b> springen und die Taste <b>Ⓜ</b> ( <b>ON</b> ) für die Rückkehr zum Einstellmenü nochmals drücken. Auf die gleiche Weise kehrt man zur Hauptseite zurück.





**Menu Mode de fonctionnement**

<table border="1" style="margin: auto;"> <tr><th colspan="2">ARBEITSMODUS</th></tr> <tr><th>MODUS</th><th>TON</th></tr> <tr><td>AUSGANG</td><td></td></tr> </table>		ARBEITSMODUS		MODUS	TON	AUSGANG	
ARBEITSMODUS							
MODUS	TON						
AUSGANG							
Mit den Tasten <b>Ⓣ</b> ( <b>DOWN</b> ) oder <b>Ⓤ</b> ( <b>UP</b> ) zu den verschiedenen Parametern springen.							
<p><b>Mode</b> Wählen Sie die Betriebsart :</p> <ul style="list-style-type: none"> <li>• Ketten (WND)</li> <li>• Winde (TON)</li> </ul>	<p>Anwählen mit <b>Ⓜ</b>  <b>Ⓣ</b> = Ja    <b>Ⓤ</b> = Nein          Bestätigen mit <b>Ⓜ</b></p>						
<p><b>Ausgang</b> Zur Rückkehr in das Einstellmenü.</p>	<p>Bestätigen mit <b>Ⓜ</b></p>						

**Mess-Menü**

<div style="border: 1px solid black; padding: 5px; margin: 0 auto; width: fit-content;"> <div style="background-color: black; color: white; padding: 2px; margin-bottom: 2px;"><b>MAB</b></div> <div style="background-color: black; color: white; padding: 2px; margin-bottom: 2px;"><b>MASSNULL.</b></div> <div style="padding: 2px;"><b>MASSEINH. MET</b></div> <div style="padding: 2px;"><b>AUSGANG</b></div> </div>	
<p>Mit der Taste  (<b>DOWN</b>) und  (<b>UP</b>) zu den verschiedenen Parametern springen.</p>	
<p><b>Massnulleinst</b> Setzt das Kettenmaß auf Null zurück (0.0).</p>	<p>Anwählen mit    = Ja    = Nein                  Bestätigen mit </p>
<p><b>Maßeinheit</b> Auswahl der Maßeinheit: Fuß / Zoll Meter / Zentimeter</p>	<p>Anwählen mit    = Fuß    = Meter                  Bestätigen mit </p>
<p><b>Ausgang</b> Zur Rückkehr in das Einstellmenü.</p>	<p>Bestätigen mit </p>









**Menü Funktionen**

<div style="border: 1px solid black; padding: 5px; margin: 0 auto; width: fit-content;"> <div style="background-color: black; color: white; padding: 2px; margin-bottom: 2px;"><b>FUNKTIONEN</b></div> <div style="background-color: black; color: white; padding: 2px; margin-bottom: 2px;"><b>FIER. ALARM 2.5</b></div> <div style="padding: 2px;"><b>AUTO. ABS. OFF</b></div> <div style="padding: 2px;"><b>FABRIKDAT</b></div> <div style="padding: 2px;"><b>AUSGANG</b></div> </div>	
<p>Mit der Taste  (<b>DOWN</b>) und  (<b>UP</b>) zu den verschiedenen Parametern springen.</p>	
<p><b>Fierenalarm</b> Die Funktion kann frei geschaltet und das Maß festgelegt werden, bei dem das Ankerspill stoppt. Danach ist nur noch die</p>	<p>Anwählen mit                   Wert einstellen mit                    Bestätigen mit </p>















<p>Tippstuerung möglich. Einstellwert: OFF, 0,5 – 1,0 – 1,5 – 2,0 – 2,5- ... 10,0 (Meter oder Fuß).</p>	
<p><b>Automatisches Abstieg</b> Schaltet durch Drücken während min. 3 Sek. der Tasten  und  das automatische Auswerfen des Ankers auf das gewünschte Maß frei. Einstellwert: OFF, 1,2,3...25 (Meter oder Fuß).</p>	<p>Anwählen mit  Wert einstellen mit   Bestätigen mit </p>
<p><b>Fabrikdaten</b> Diese Funktion ermöglicht den Aufruf der ursprünglichen Werkseinstellungen und löscht alle gespeicherten Einstellungen. <b>Diese Steuerfunktion nur bei falscher Programmierung verwenden.</b></p>	<p>Anwählen mit   = Ja    = Nein Bestätigen mit </p>
<p><b>Ausgang</b> Zur Rückkehr in das Einstellmenü.</p>	<p>Bestätigen mit </p>

**Einstellmenü**

<table border="1" style="margin: auto;"> <thead> <tr> <th colspan="2" style="background-color: black; color: white;">PARAMETER</th> </tr> </thead> <tbody> <tr> <td style="background-color: black; color: white;">KONTRAST</td> <td style="text-align: right;">3</td> </tr> <tr> <td>LCD LITCH</td> <td style="text-align: right;">5</td> </tr> <tr> <td>FREIZEIT</td> <td style="text-align: right;">30</td> </tr> <tr> <td>SPRACHE</td> <td style="text-align: right;">ITA</td> </tr> <tr> <td>AUSGANG</td> <td></td> </tr> </tbody> </table>		PARAMETER		KONTRAST	3	LCD LITCH	5	FREIZEIT	30	SPRACHE	ITA	AUSGANG	
PARAMETER													
KONTRAST	3												
LCD LITCH	5												
FREIZEIT	30												
SPRACHE	ITA												
AUSGANG													
<p>Mit der Taste  (DOWN) und  (UP) zu den verschiedenen Parametern springen.</p>													
<p><b>LCDKontrast</b> Durch Freischaltung dieser Funktion kann das Programmierverfahren des Kontrasts des <i>Displays</i> frei geschaltet werden.</p>	<p>Anwählen mit  Wert einstellen mit   Bestätigen mit </p>												
<p><b>LCD Litch</b> Durch Freischaltung dieser Funktion kann das Programmierverfahren der Lichtstärke des <i>Displays</i> frei geschaltet werden.</p>	<p>Anwählen mit  Wert einstellen mit   Bestätigen mit </p>												
<p><b>BackLight Zeit</b> Mit dieser Funktion kann die Zeit eingestellt</p>	<p>Anwählen mit </p>												

werden, während der das <i>Display</i> nach dem letzten Steuerbefehl beleuchtet bleibt (Default-Wert 30 Sekunden).	Wert einstellen mit   Bestätigen mit 
<b>Sprache</b> Die Sprache des <i>Displays</i> kann ausgewählt werden: Italiano, English, Français, Deutsch, Español	Anwählen mit  Wert einstellen mit   Bestätigen mit 
<b>Ausgang</b> Zur Rückkehr in das Einstellmenü.	Bestätigen mit 

**Menü Sensorkalibrierung**

<table border="1" style="margin: auto;"> <thead> <tr> <th colspan="2">SENSOR</th> </tr> <tr> <th>SENSOR</th> <th>STD</th> </tr> </thead> <tbody> <tr> <td>KETTENUS</td> <td>33.0</td> </tr> <tr> <td>TEILUNGS.</td> <td>1</td> </tr> <tr> <td>TEST</td> <td></td> </tr> <tr> <td>AUSGANG</td> <td></td> </tr> </tbody> </table>		SENSOR		SENSOR	STD	KETTENUS	33.0	TEILUNGS.	1	TEST		AUSGANG	
SENSOR													
SENSOR	STD												
KETTENUS	33.0												
TEILUNGS.	1												
TEST													
AUSGANG													
Mit der Taste  ( <b>DOWN</b> ) und  ( <b>UP</b> ) zu den verschiedenen Parametern springen.													
<b>Sensor</b> Hier können Sie den Sensortyp einstellen: <ul style="list-style-type: none"> <li>• Standard oder 2-Draht (STD)</li> <li>• Elektronisch oder 3-Draht (HAL)</li> </ul>	Anwählen mit  Wert einstellen mit   Bestätigen mit 												
<b>Zigeunerumfang</b> In dieser Zeile müssen Sie den Umfang des Zigeuners eingeben (in Zentimetern oder Zoll). Informationen zur Eingabe des korrekten Werts finden Sie im Abschnitt „Gerätekalibrierung“.	Anwählen mit  Wert einstellen mit   Bestätigen mit 												
<b>Teiler</b> Wenn der Standard-2-Draht-Sensor (STD) verwendet wird, muss dieser Wert bei 1 belassen werden. Wenn ein elektronischer Sensor verwendet wird, muss dieser der Anzahl der Sensorimpulse für jede Umdrehung des Barbotins entsprechen. Siehe Abschnitt "Gerätekalibrierung".	Anwählen mit  Wert einstellen mit   Bestätigen mit 												

<p><b>Sensor Test</b> Mit dieser Funktion können Sie den korrekten Betrieb des Drehzahlmessersensors überprüfen: Ein Bildschirm mit dem Status des Sensors wird angezeigt: Durch Drehen der Winde muss der Kontakt geschlossen werden, wenn die Mangete in Übereinstimmung mit dem Sensor vorbeifährt, und ihn schließen.</p>	<p>Anwählen mit Ⓜ</p> <div data-bbox="557 260 784 486" style="border: 1px solid black; padding: 10px; text-align: center;"> <p><b>SENSOR</b></p>  </div> <p>Bestätigen mit Ⓜ</p>
<p><b>Ausgang</b> Zur Rückkehr in das Einstellmenü.</p>	<p>Bestätigen mit Ⓜ</p>

**Menü Überprüfungen**

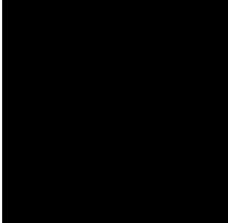
<div data-bbox="442 769 666 997" style="border: 1px solid black; padding: 5px; margin: auto;"> <p><b>KONTROLLE</b></p> <p><b>LCD TEST</b></p> <p><b>SOFTWARE 1.0</b></p> <p><b>BETRIEBS. 0</b></p> <p><b>AUSGANG</b></p> </div>	
<p>Mit der Taste Ⓣ (DOWN) und Ⓢ (UP) zu den verschiedenen Parametern springen.</p>	
<p><b>LCD Test</b> Diese Funktion schaltet alle <i>Pixel</i> des <i>Displays</i> zur Überprüfung ein.</p>	<p>Anwählen mit Ⓜ</p> <div data-bbox="557 1157 784 1380" style="border: 1px solid black; padding: 10px; text-align: center;">  </div> <p>Bestätigen mit Ⓜ</p>

<b>Sw. Version</b> Anzeige der <i>Software</i> -Version.	
<b>Betriebszeit</b> Anzeige der Betriebsstunden des Ankerspills.	
<b>Ausgang</b> Zur Rückkehr in das Einstellmenü.	Bestätigen mit 

## Kalibrierung des Instruments

Auswahl der **MESSEINHEIT** (Meter oder Fuß), die im Menü Messen eingestellt werden kann

Einstellen des **SENSOR-Typs** (Standard oder Elektronik) im Sensor-Menü

Einstellen des Umfangs des BARBOTIN (in cm oder Zoll) im Menü Sensor: Der einzugebende Wert ist der Umfang am Wicklungspunkt der Kette. Wenn der Wert aus der technischen Dokumentation der Winde nicht bekannt ist, muss die Kettenlänge gemessen werden, die der Zigeuner über seinen gesamten Umfang aufnehmen kann. Diese Messung in Zentimetern (oder Zoll, abhängig von der Maßeinheit) ist der Wert, der in den Parameter BARBOTIN eingegeben werden muss

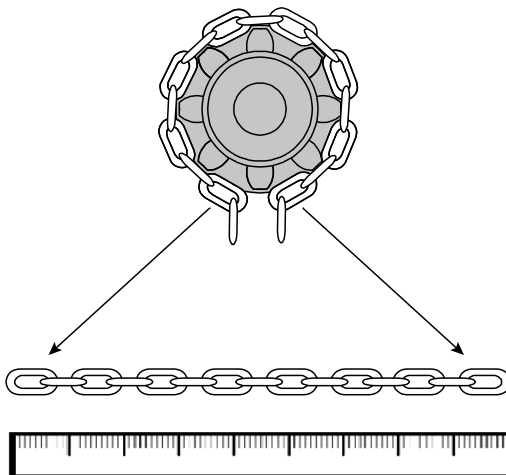

CIRCONFERENZA BARBOTIN

Einstellen des **DIVIDER** im Menü Sensor: Wenn ein Standardsensor verwendet wird, muss dieser Wert auf 1 gesetzt werden. Wenn ein elektronischer Sensor verwendet wird, muss dieser der Anzahl der Sensorimpulse für jede Umdrehung des Barbotins entsprechen



## Gebrauch

Die Taste **Ⓢ** (**ON**) zur Aktivierung der Steuerungen und Beleuchtung des *Displays* drücken. Die *Display*-Beleuchtung wird 30 Sekunden nach dem letzten Steuerbefehl ausgeschaltet (änderbare *Default*-Zeit–siehe “Zeit BkLight”).

Die Taste **Ⓢ** (**UP**) steuert das Lichten des Ankers.

Die Taste **Ⓢ** (**DOWN**) steuert das Auswerfen.



Sobald die Taste (**UP** oder **DOWN**) losgelassen wird, stoppt die entsprechende Bewegung.

## Maß-Reset

Zum Zurücksetzen der Maß-Zählung die Taste **Ⓢ** (**ON**) und gleichzeitig die Taste **Ⓢ** (**UP**) mindestens drei Sekunden lang drücken.

Die Maßzurücksetzung kann auch im **Mess**-Menü durch Anwählen von “**Ja**” in der Zeile **Maßnulleinst** erfolgen.

## Automatisches Auswerfen des Ankers

Diese Funktion muss im Menü **Alarmer und Funktionen** frei geschaltet werden (per *Default* ist die Funktion ausgeschaltet).

“**Autom.Abstieg**” anwählen und den gewünschten Stoppwert des Ankers eingeben. Nach der Eingabe des Masses die Taste **Ⓢ** (**ON**) und gleichzeitig die Taste **Ⓢ** (**DOWN**) mindestens drei Sekunden lang drücken. Sobald der Anker in Bewegung ist, die Tasten loslassen.

**Aus Sicherheitsgründen kann das automatische Auswerfen des Ankers durch Drücken einer beliebigen Taste des Instruments unterbrochen werden.**

**Betriebsstörungen**

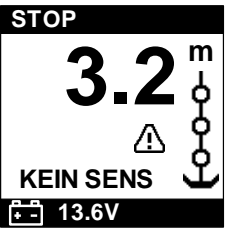
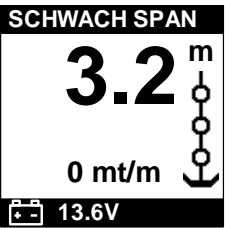
MELDUNG	URSACHE	BEHEBUNG
 <p>The screenshot shows a black display with white text. At the top, it says 'STOP'. Below that is '3.2 m' with a vertical scale icon to the right. A warning triangle is in the center. Below the triangle, it says 'KEIN SENS'. At the bottom, there is a battery icon and '13.6V'.</p>	<p>Während die Taste <b>UP</b> oder <b>DOWN</b> gedrückt wurde, hat das Instrument mehr als 5 Sekunden lang kein Signal vom Magnetsensor erhalten.</p>	<p>Die Stromanschlüsse des Sensors überprüfen.</p> <p>Die Funktionsweise des Sensors überprüfen und diesen eventuell ersetzen.</p> <p>Die Position des Sensors, des Magnets auf der Kettennuss und den Abstand zwischen den beiden (3 mm) überprüfen.</p> <p>Die Funktionsweise der elektrischen Anlage oder des Ankerspills überprüfen.</p>
 <p>The screenshot shows a black display with white text. At the top, it says 'SCHWACH SPAN'. Below that is '3.2 m' with a vertical scale icon to the right. Below the scale, it says '0 mt/m'. At the bottom, there is a battery icon and '13.6V'.</p>	<p>Die Anschlussspannung des Instruments ist niedriger als 10V.</p>	<p>Den Ladezustand der Batterie oder die Funktionsweise der elektrischen Ausrüstung kontrollieren.</p>

**Garantie**

Unsere Artikel haben eine Garantie gegen Produktionsfehler von 2 Jahre ab dem Kaufdatum (Kassenbon oder anderer Kaufbeleg). In der Garantie sind nicht enthalten: Störungen oder Beschädigungen durch den Transport, Eingriffe wegen falscher Installierung, Störungen durch falscher Anwendung des Apparates. Die Garantie entfällt falls die Reparatur durch von der Firma nicht autorisierte Personen oder mit nicht originalen Ersatzteilen erfolgt. Die Garantie sieht auf keinen Fall den kompletten Ersatz des Apparates. Die Garantie haftet nur für mangelhafte Teile und der relativen Arbeitszeit. Sie deckt nicht den Transport oder die Aufwandsentschädigung. Der Kunde kann keine Erstattung der Unkosten verlangen.

## Descripción

El cuentametros **HC020** permite zarpar o tirar el ancla con la visualización de los metros o pies de cadena desenrollada y de la velocidad de la misma.

## Datos técnicos

Tensión de alimentación	entre 10 y 30 V DC
Consumo de corriente	mín. 5 mA / máx. 50 mA
Grado de protección	IP67
Temperatura operativa	0 / +70 °C (32 / 158 °F)
Monitor gráfico	128 x 128 pixeles
Medición máxima posible	999 metros / 999 pies
Tamaño (mm)	170 x 80 x 50
Peso (g)	450*

\* con cable



**Atención**

**ALIMENTAR EXCLUSIVAMENTE CON CORRIENTE CONTINUA.**

## Notas de carácter general

El cuentametros **HC020** debe ser utilizado para los fines descritos en este manual: accionamiento y visualización de los metros/pies de cadena desenrollados desde un molinete. Cualquier otro uso se considerará como impropio.

**La alteración del instrumento provocará la invalidación inmediata de la garantía.**

## Componentes

Componentes:

cuentametros con cable extensible y kit de fijación (1 elemento de fijación con 2 tornillos);  
toma conector de 6 polos con gumiación, 4 tornillos de fijación con anillos separadores y tapón de cierre;  
instrucciones de uso.

## Instalación

**En algunos modelos de torno de ancla el sensor y el imán se encuentran ya instalados (predisposición cuentametros) por lo que no es necesario efectuar las operaciones que se indican a continuación.**

### Instalación del imán en el molinete

Se debe practicar un agujero en un resalte del barbotén de diámetro 6,5 mm (~1/4") y profundidad 8 mm (5/16"). Practicar este agujero en una zona no coincidente con el paso de la cadena.

En el caso de molinetes de eje vertical (véase Fig. 1B), practicar el agujero en la circunferencia inferior del barbotén.

En el caso de molinetes de eje horizontal (véase Fig. 2B), practicar el agujero en la circunferencia externa del barbotén.

Controlar que durante la rotación del barbotén, la parte saliente del imán no golpee ni la base ni el sensor.

Introducir el imán en el agujero por la parte metálica dejando que la parte protegida sobresalga en la medida aproximada de 2 mm. Fijar el imán utilizando un pegamento para metales (cola epoxídica bi-componente) o silicona. El pegamento utilizado debe ser resistente al ambiente marino.

### Montaje sensor magnético para molinetes de eje vertical

(véanse Fig. 1A y 1B)

Practicar en la cubierta un agujero de diámetro 4 mm (~3/16") para permitir el paso del cable del sensor.

Fijar el elem. A del soporte, utilizando para ello los dos tornillos adjuntos, una vez posicionada la junta tórica en la parte inferior del mismo.

Introducir el elem. B, con el sensor magnético, en el soporte A y regular su altura de manera que quede alineado con el imán fijado en el barbotén.

Acercar el sensor de manera que quede a una distancia aproximada de 3 mm (~1/8") respecto del imán y fijarlo apretando el tornillo G1. A continuación, apretar el tornillo G2.

### Montaje sensor magnético para molinetes de eje horizontal

(véanse Fig. 2A, 2B y 2C)

Practicar en la cubierta un agujero de diámetro 4 mm (~3/16") para permitir el paso del cable del sensor.

Fijar el elem. A del soporte, utilizando para ello los dos tornillos adjuntos, una vez posicionada la junta tórica en la parte inferior del mismo.

Mediante una sierra cortar a la medida el elem. C. El sensor debe quedar posicionado aproximadamente a 3 mm (~1/8") respecto del imán.

Introducir el elem. C, con el sensor magnético, en el soporte A y fijarlo utilizando un pegamento para materiales plásticos (cola epoxídica bi-componente) o silicona.

Utilizando el mismo pegamento, fijar el sensor en el elem. C.

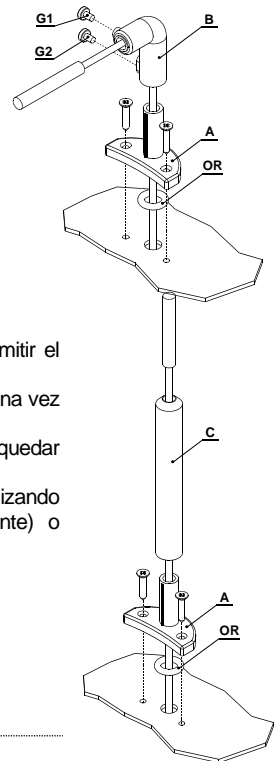

### Instalación del cuentametros

(véase esquema eléctrico)



**Atención**

**DESCONECTAR SIEMPRE LA BATERÍA ANTES DE EFECTUAR LA INSTALACIÓN.**

El cuentametros debe quedar colocado de manera que la pantalla pueda ser leída con facilidad y sin que quede expuesta a los rayos solares.

Fijar el instrumento utilizando el elemento de fijación adjuntos, apretando los dos tornillos con un destornillador tipo Phillips.

Practicar en el panel del puente de mando un agujero de diámetro 20,5 mm (~3/16") y 4 agujeros de diámetro 2,2 mm (~3/32") destinados a fijar la toma del conector.

La guarnición debe ser colocada entre la toma y el panel del puente de mando.

La parte trasera debe estar protegida del contacto con el agua o de la humedad.

Para efectuar la conexión eléctrica aplicar las instrucciones que aparecen en el esquema anexo. La sección mínima de los cables debe ser de 1,5 mm<sup>2</sup>.

Instalar un fusible de protección rápido de 3 A (amperios) en el cable (+) de la batería. No utilizar para la alimentación la tensión proveniente del conjunto de baterías de los motores.

El instrumento está conforme con lo establecido por los estándares EMC (EN55022) y debe ser posicionado a una distancia de:

- 30 cm (~1 Ft) respecto de la brújula;
- 50 cm (~1,5 Ft) respecto de aparatos radiorreceptores;
- 2 metros (~6,5 Ft) respecto de aparatos radiotransmisores;
- 2 metros (~6,5 Ft) respecto de la banda radar.

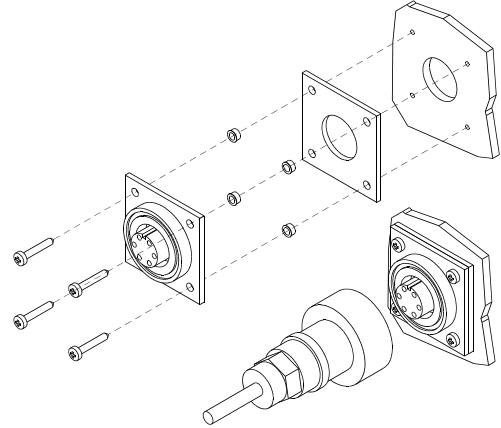

**Conexiones**

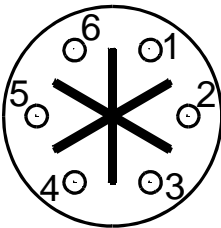

CONECTOR TRASERO DE 6 POLOS	
PIN	SEÑAL
1	- batería
2	+ batería
3	Mando DOWN
4	Mando UP
5	Sensor magnético
6	

**Perforación conector y sensor**

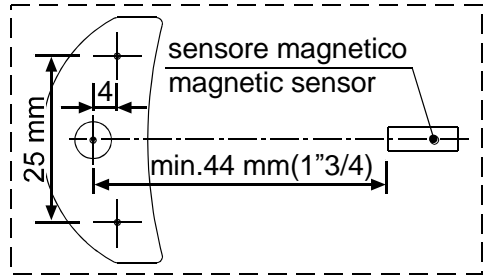
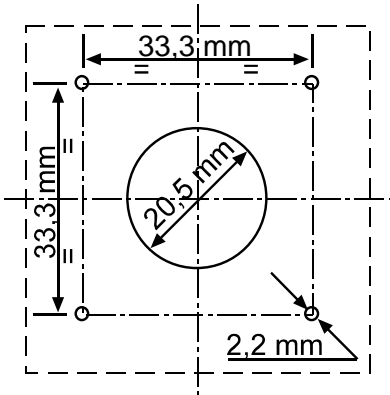

**Primer encendido**

El cuentametros está provisto de un monitor gráfico y de tres teclas: **ON**, **UP** y **DOWN**. La tecla **ON** enciende el monitor y habilita las dos teclas restantes. Debe utilizarse para obtener acceso a los menús de configuración de los parámetros, para seleccionar los parámetros a modificar y para confirmar los valores incorporados. El monitor se apagará 30 segundos después del último mando dispuesto (tiempo *predeterminado* modificable, véase “Tiempo Ilum.”).

La tecla **UP** manda la subida del ancla mientras que la tecla **DOWN** la bajada. Al soltar cada tecla se interrumpirá la respectiva maniobra. Durante la configuración de los parámetros estas dos teclas permiten desplazarse en el ámbito del menú y modificar los respectivos valores.

Al encenderlo, el instrumento emitirá un sonido y durante algunos segundos aparecerá la siguiente página:



Una vez concluido el procedimiento de inicialización, aparecerá la página principal.  
En la que:



**ESTADO:** indica el estado del instrumento así como posibles anomalías.

**VELOCIDAD:** indica la velocidad de la cadena, en subida o bajada, en metros por minuto o en pies por minuto.

**CONTEO:** indica en metros o pies la cantidad de cadena bajada.

**MONITOREO:** indica la tensión de alimentación.

**CAMBIO DE MODO:** este icono aparece cuando cambia el modo de cabrestante / deformación

**ANIMACIÓN:** se muestra una cadena o una deformación para indicar la dirección del movimiento

Al efectuar el primer encendido, el instrumento se presentará de la manera configurada en fábrica (véase tabla).

Parámetro	Valor predeterminado
Alarma Subida	3.0 metros
Auto Bajada	Off
Tiempo Iluminación	30 segundos
Unidad de medida	Metros/centímetros
Medida cadena	0.0 metros
Vuelta Molinete	33 cm
Tipo sensor	desconocido
Idioma	Italiano
Tempo Funcionamiento	0
Factor de división	1

## Modo cabrestante / tonelaje

El contador de metros HC020 tiene dos modos de funcionamiento diferentes: modo cabrestante y modo y tonelaje.

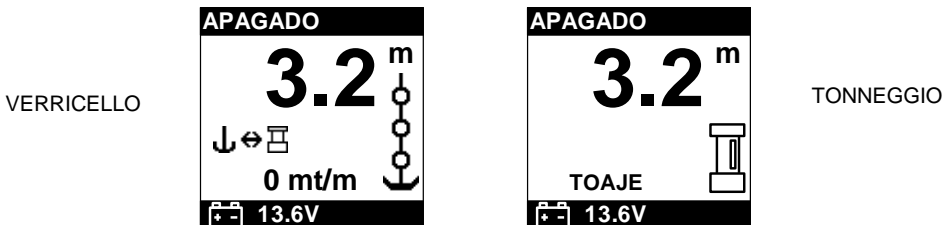

Cuando se enciende el instrumento se posiciona en modo cabrestante que es por tanto el modo de funcionamiento estándar: es posible operar el cabrestante obteniendo la medida de los metros de cadena bajada, el cálculo de la velocidad del ancla y posiblemente la señal de error del sensor en caso de anomalías o fallas en el sensor del cuentarrevoluciones instalado a bordo del cabrestante.

En el modo de amarre, en cambio, se activa el amarre para operaciones normales de atraque en puerto pero sin leer el sensor del tacómetro; en este modo, por lo tanto, la longitud de la cadena no varía, la velocidad de la cadena no se muestra y no se da ninguna señal sobre el estado del sensor que no está realmente en uso porque la cadena está estacionaria.

Para cambiar de un modo a otro, presione el botón (ON) durante 3 segundos para que aparezca el icono de cambio de modo:









cuando aparezca, suelte el botón (ON) cambia de cabrestante a amarre o viceversa.

**Menú de configuración cuentametros**









<p>Manteniendo presionada la tecla <b>Ⓞ (ON)</b> durante seis segundos, se encenderá el menú de configuración del instrumento. En el monitor aparecerá la siguiente página:</p> <p>Utilizar la tecla <b>Ⓣ (DOWN)</b> o <b>Ⓤ (UP)</b> para desplazarse entre las opciones del menú.</p>	
<p>Una vez elegida la opción a modificar, presionar la tecla <b>Ⓞ (ON)</b> para confirmar la selección efectuada.</p>	
<p>Utilizar la tecla <b>Ⓣ (DOWN)</b> o <b>Ⓤ (UP)</b> para desplazarse entre los parámetros.</p>	
<p>Una vez elegido un parámetro, presionar la tecla <b>Ⓞ (ON)</b> para habilitar la modificación.</p>	
<p>En función del tipo de parámetro, utilizando la tecla <b>Ⓣ (DOWN)</b> o <b>Ⓤ (UP)</b> será posible reducir/aumentar el valor del mismo o inhabilitar/habilitar la función.</p>	
<p>Una vez efectuada la modificación, presionar la tecla <b>Ⓞ (ON)</b> para confirmar.</p>	
<p>Operar con la tecla <b>Ⓣ (DOWN)</b> para situarse sobre la opción <b>Salida</b> y presionar nuevamente la tecla <b>Ⓞ (ON)</b> para retornar al menú de configuración. El mismo procedimiento deberá utilizarse para retornar a la página principal.</p>	





**Menù Modo de Funcionamento**

















<div style="border: 1px solid black; padding: 5px; margin: 0 auto; width: 150px;"> <div style="background-color: black; color: white; padding: 2px; text-align: center; font-weight: bold;">MODO TRABAJO</div> <div style="background-color: black; color: white; padding: 2px; text-align: center; font-weight: bold;">MODO WND</div> <p style="text-align: center;">SALIDA</p> </div>	
<p>Utilizar la tecla  (DOWN) o  (UP) para desplazarse entre los parámetros.</p>	
<p><b>Modo</b>                  Seleccione el modo de funcionamiento:</p> <ul style="list-style-type: none"> <li>• Cabrestante (VER)</li> <li>• Tonelaje (TON)</li> </ul>	<p>Seleccionar con </p> <p>Incorporar el valor con  </p> <p>Confirmar con </p>
<p><b>Salida</b>                  Para retornar al menù de configuración.</p>	<p>Confirmar con </p>

**Menù de medición**



















<div style="border: 1px solid black; padding: 5px; margin: 0 auto; width: 150px;"> <div style="background-color: black; color: white; padding: 2px; text-align: center; font-weight: bold;">MEDIDA</div> <div style="background-color: black; color: white; padding: 2px; text-align: center; font-weight: bold;">RES. MED.</div> <p style="text-align: center;">UNIDAD M. MET</p> <p style="text-align: center;">SALIDA</p> </div>	
<p>Utilizar la tecla  (DOWN) o  (UP) para desplazarse entre los parámetros.</p>	
<p><b>Reseteo Medida</b>                  Poner en cero el valor de medición de la cadena (0.0).</p>	<p>Seleccionar con </p> <p> = Sí  = No</p> <p>Confirmar con </p>
<p><b>Unidad de medida</b>                  Se selecciona la unidad de medida:</p>	<p>Seleccionar con </p> <p> = Pies  = Metros</p>

Pies / pulgadas Metros / centímetros	Confirmar con 
<b>Salida</b> Para retornar al menú de configuración.	Confirmar con 

**Menú de funciones**

<table border="1" style="margin: auto;"> <tr> <th colspan="2">FUNCIONES</th> </tr> <tr> <td>AL. SUBIDA</td> <td>2.5</td> </tr> <tr> <td>BAJADA</td> <td>OFF</td> </tr> <tr> <td>DATO FAB</td> <td></td> </tr> <tr> <td>SALIDA</td> <td></td> </tr> </table>		FUNCIONES		AL. SUBIDA	2.5	BAJADA	OFF	DATO FAB		SALIDA	
FUNCIONES											
AL. SUBIDA	2.5										
BAJADA	OFF										
DATO FAB											
SALIDA											
Utilizar la tecla  (DOWN) o  (UP) para desplazarse entre los parámetros.											
<p><b>Alarma Subida</b> Es posible habilitar la función y establecer la cuota a la cual el molinete se detiene; después de lo cual es posible operar sólo con el mando por impulsos. Valor programable: OFF, 0.5 – 1.0 – 1.5 – 2.0 – 2.5...10.0 (metros o pies).</p>	<p>Seleccionar con </p> <p>Incorporar el valor con  </p> <p>Confirmar con </p>										
<p><b>Auto Bajada</b> Habilita el procedimiento de bajada automática del ancla a la cota programada, con la presión (al menos durante 3 s) de las teclas  y . Valor programable: OFF, 1,2,3...25 (metros o pies).</p>	<p>Seleccionar con </p> <p>Incorporar el valor con  </p> <p>Confirmar con </p>										
<p><b>Datos de Fábrica</b> Esta función permite convocar los datos originales, incorporados en fábrica, <u>cancelando las configuraciones almacenadas.</u> <b>Usar este mando sólo en caso de programación errónea.</b></p>	<p>Seleccionar con </p> <p> = Sí    = No</p> <p>Confirmar con </p>										
<p><b>Salida</b> Para retornar al menú de configuración.</p>	<p>Confirmar con </p>										

**Menú de configuraciones**







<b>AJUSTES</b>	
<b>CONTRASTE 3</b>	
<b>LIGERA 5</b>	
<b>TIEMPO 30</b>	
<b>LENGUAJE ITA</b>	
<b>SALIDA</b>	
<p>Utilizar la tecla  (<b>DOWN</b>) o  (<b>UP</b>) para desplazarse entre los parámetros.</p>	
<p><b>Contraste</b> Habilitando esta función es posible activar el procedimiento de programación de contraste del monitor.</p>	<p>Seleccionar con  Incorporar el valor con   Confirmar con </p>
<p><b>Iluminación</b> Habilitando esta función es posible activar el procedimiento de programación de la intensidad luminosa del monitor.</p>	<p>Seleccionar con  Incorporar el valor con   Confirmar con </p>
<p><b>Tiempo Iluminación</b> Esta función permite programar el tiempo durante el cual el monitor permanece encendido después del último mando lanzado (valor predeterminado 30 segundos).</p>	<p>Seleccionar con  Incorporar el valor con   Confirmar con </p>
<p><b>Lenguaje</b> Es posible seleccionar el idioma del monitor: Italiano, English, Français, Deutsch, Español</p>	<p>Seleccionar con  Incorporar el valor con   Confirmar con </p>
<p><b>Salida</b> Para retornar al menú de configuración.</p>	<p>Confirmar con </p>

**Menú de calibración sensor**

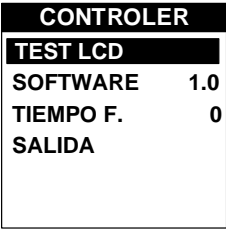
<table border="1" style="margin: auto;"> <thead> <tr> <th colspan="2">SENSOR</th> </tr> <tr> <th>SENSOR</th> <th>STD</th> </tr> </thead> <tbody> <tr> <td>MOLINETE</td> <td>33.0</td> </tr> <tr> <td>FACTOR D.</td> <td>1</td> </tr> <tr> <td>TEST</td> <td></td> </tr> <tr> <td>SALIDA</td> <td></td> </tr> </tbody> </table>		SENSOR		SENSOR	STD	MOLINETE	33.0	FACTOR D.	1	TEST		SALIDA	
SENSOR													
SENSOR	STD												
MOLINETE	33.0												
FACTOR D.	1												
TEST													
SALIDA													
<p>Utilizar la tecla ⏴ (DOWN) o ⏵ (UP) para desplazarse entre los parámetros.</p>													
<p><b>Sensor</b> Le permite configurar el tipo de sensor:</p> <ul style="list-style-type: none"> <li>• Estándar o 2 hilos (STD)</li> <li>• Electrónico o de 3 hilos (HAL)</li> </ul>	<p>Seleccionar con Ⓚ Incorporar el valor con ⏴ ⏵ Confirmar con Ⓚ</p>												
<p><b>Circunferencia gitana</b> En esta fila debes ingresar la circunferencia del Gitano (en centímetros o pulgadas). Para ingresar el valor correcto, consulte el párrafo "Calibración del instrumento".</p>	<p>Seleccionar con Ⓚ Incorporar el valor con ⏴ ⏵ Confirmar con Ⓚ</p>												
<p><b>Divisor</b> Si se utiliza el sensor estándar de 2 hilos (STD), este valor debe dejarse en 1. si se usa un sensor electrónico debe ser igual al número de pulsos del sensor por cada vuelta del barbotín. Ver párrafo "Calibración del instrumento".</p>	<p>Seleccionar con Ⓚ Incorporar el valor con ⏴ ⏵ Confirmar con Ⓚ</p>												
<p><b>Prueba</b> Esta función permite comprobar el correcto funcionamiento del sensor del tacómetro: se muestra una pantalla con el estado del sensor: al girar el cabrestante, el contacto debe cerrarse cuando el mangete pasa en correspondencia con el sensor, cerrándolo.</p>	<table border="1" style="margin: auto;"> <tr> <td colspan="2" style="text-align: center;"><b>SENSOR</b></td> </tr> <tr> <td colspan="2" style="text-align: center;">—</td> </tr> <tr> <td style="text-align: center;">—○</td> <td style="text-align: center;">○—</td> </tr> </table>	<b>SENSOR</b>		—		—○	○—						
<b>SENSOR</b>													
—													
—○	○—												
<p>Seleccionar con Ⓚ Incorporar el valor con ⏴ ⏵ Confirmar con Ⓚ</p>													

<b>Salida</b> Para retornar al menú de configuración.	Confirmar con 
--	---

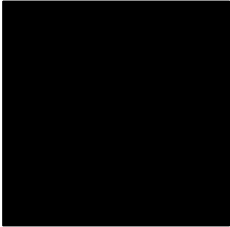
**Menú de verificaciones**

	
<p>Utilizar la tecla  (<b>DOWN</b>) o  (<b>UP</b>) para desplazarse entre los parámetros.</p>	
<p><b>Test LCD</b> Esta función enciende todos los <i>pixeles</i> del monitor a fin de efectuar la verificación del mismo.</p>	<p>Seleccionar con </p>  <p>Confirmar con </p>
<p><b>Version Software</b> Indica la versión del <i>software</i>.</p>	
<p><b>Tiempo Funcionamiento</b> Indica las horas de funcionamiento del torno.</p>	
<b>Salida</b> Para retornar al menú de configuración.	Confirmar con 

**Calibración del instrumento**

- Elección de **UNIDAD DE MEDIDA** (metros o pies) que se puede configurar en el menú Medida

- Configuración del tipo de **SENSOR** (estándar o electrónico) en el menú Sensor
- Configuración de la circunferencia del **BARBOTIN** (en cm o pulgadas) en el menú Sensor: el valor a ingresar es la circunferencia en el punto de enrollamiento de la cadena. Si el valor no se conoce de la documentación técnica del cabrestante, es necesario medir la longitud de la cadena que el gitano puede acomodar a lo largo de toda su circunferencia. Esta medida expresada en centímetros (o pulgadas según la unidad de medida) es el valor que se debe ingresar en el parámetro **BARBOTIN**

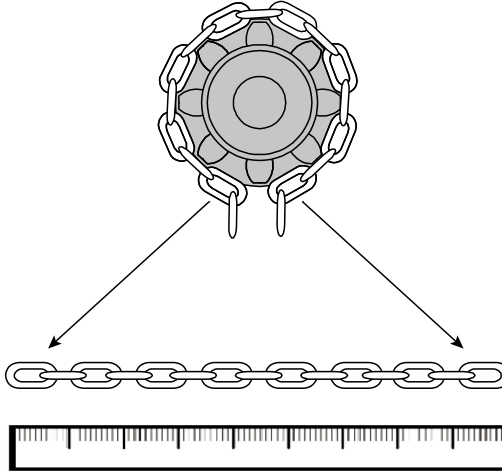

CIRCONFERENZA BARBOTIN

- Configuración del **DIVISOR** en el menú Sensor: si se usa un sensor estándar, este valor debe establecerse en 1 mientras que si se usa un sensor electrónico debe ser igual al número de pulsos del sensor por cada vuelta del barbotin

### Uso

Presionar la tecla **(ON)** para activar los mandos e iluminar el monitor. El monitor se apaga 30 segundos después de lanzarse el último mando (tiempo predeterminado modificable, véase "Tiempo Ilum.").

Presionando la tecla **(UP)** se obtiene la subida del ancla.

Presionando la tecla **(DOWN)** se baja el ancla.

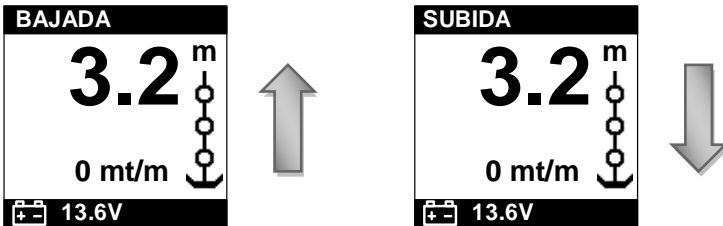

Al soltar cada tecla de mando (**UP** o **DOWN**) se interrumpirá la respectiva maniobra.

### Reseteo de la medición

Para poner en cero el conteo de medición presionar simultáneamente las teclas **(ON)** y **(UP)** al menos durante tres segundos.

La puesta en cero de la medición puede efectuarse también desde el menú **Medición**, seleccionando **"SI"** en la línea **Reseteo Medida**.



### Bajada automática del ancla

Esta función debe ser habilitada desde el menú **Alarmas y Funciones** (esta función queda inhabilitada en fábrica).

Seleccionar la línea **"Auto Bajada"** y programar la cota a la cual el ancla deberá detenerse. Después, presionar de modo simultáneo la tecla **(ON)** y la tecla **(DOWN)** al menos durante tres segundos. Soltar las teclas una vez que el ancla comienza a bajar.

**En todo caso, por razones de seguridad, será posible interrumpir la bajada automática presionando una cualquiera de las teclas del instrumento.**

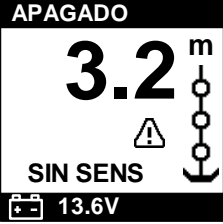
**Anomalías de funcionamiento**

SEÑAL	CAUSA	REMEDIO
	<p>Mientras se mantiene presionada la tecla <b>UP</b> o <b>DOWN</b> el instrumento no recibe ninguna señal proveniente del sensor magnético durante un lapso superior a 5 segundos.</p>	<p>Controlar las conexiones eléctricas del sensor.</p> <p>Controlar el estado del sensor y sustituirlo en caso de estar averiado.</p> <p>Controlar la posición del sensor, del imán en el barbotén y la distancia entre ambos (3 mm).</p> <p>Controlar el funcionamiento del sistema eléctrico o del molinete.</p>
	<p>La tensión de alimentación del instrumento es inferior a 10 V.</p>	<p>Controlar el nivel de carga de la batería o el funcionamiento del sistema eléctrico.</p>

**Garantía**

Nuestros artículos están garantizados contra eventuales defectos de fabricación pro 2 años a partir de la fecha de compra (servirá de constancia el recibo fiscal u otra prueba de compra). No están incluidas en la garantía: averías y roturas causadas por el transporte, intervenciones efectuadas por problemas causados por errónea instalación, averías causadas por uso inapropiado del aparato. La garantía caduca en la hipótesis de mantenimiento o reparaciones efectuadas por personas no autorizadas por la empresa o ejecutadas con aplicación de repuestos no originales. La garantía no prevé en ningún caso la completa sustitución del aparato. La garantía se refiere exclusivamente a la sustitución de repuestos defectuosos y correspondiente mano de obra. No comprende el transporte o los gastos de traslado. El Cliente no podrá pretender ningún reembolso por los gastos sostenido.



# SCHEMA ELETTICO / ELECTRICAL DRAWING

## Sensore magnetico reed (2 fili) / Reed magnetic sensor (2 wires)

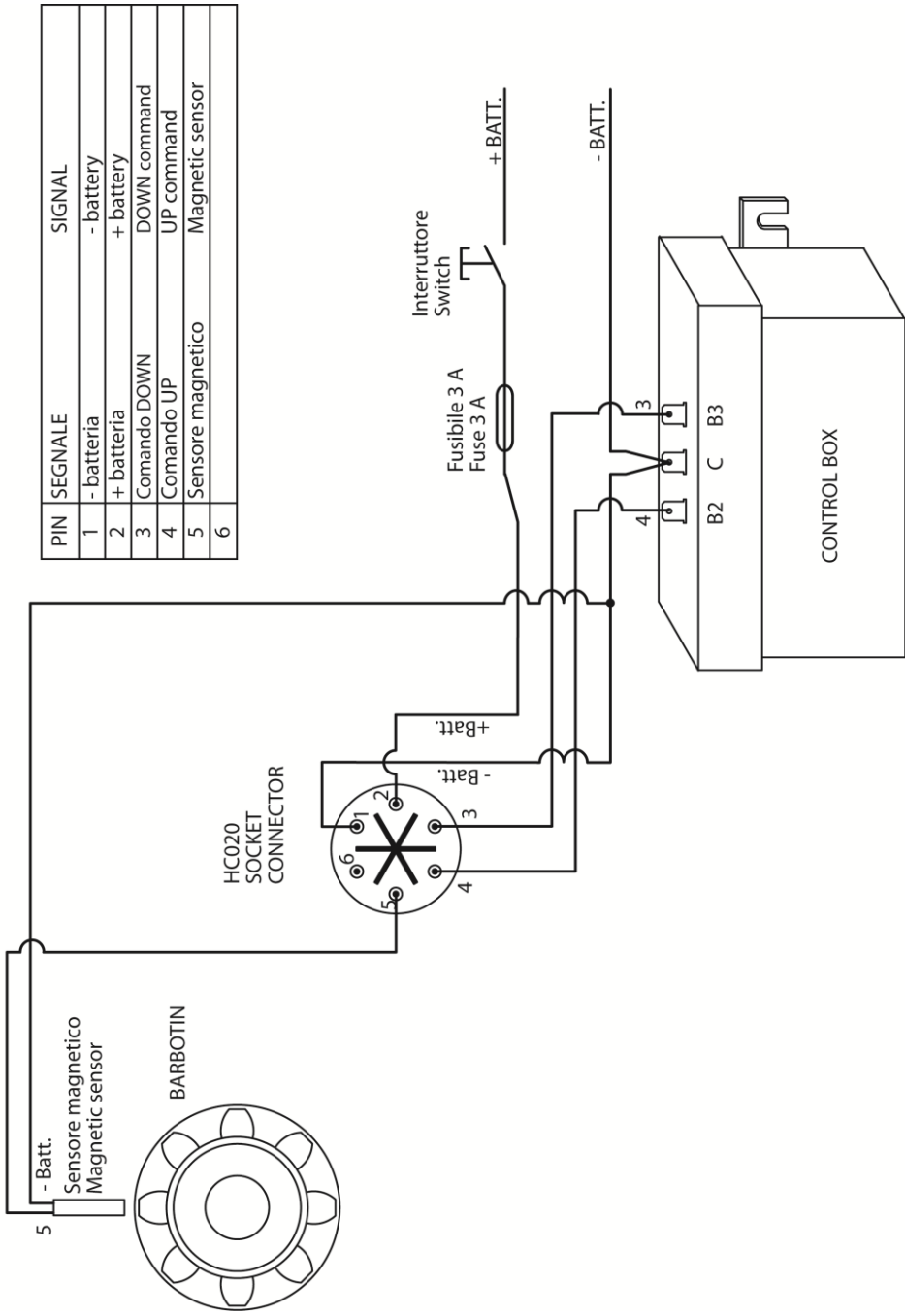

PIN	SEGNALE	SIGNAL
1	- batteria	- battery
2	+ batteria	+ battery
3	Comando DOWN	DOWN command
4	Comando UP	UP command
5	Sensore magnetico	Magnetic sensor
6		

# SCHEMA ELETTRICO / ELECTRICAL DRAWING

## Sensore magnetico elettronico (3 fili) / Electronic magnetic (3 wires)

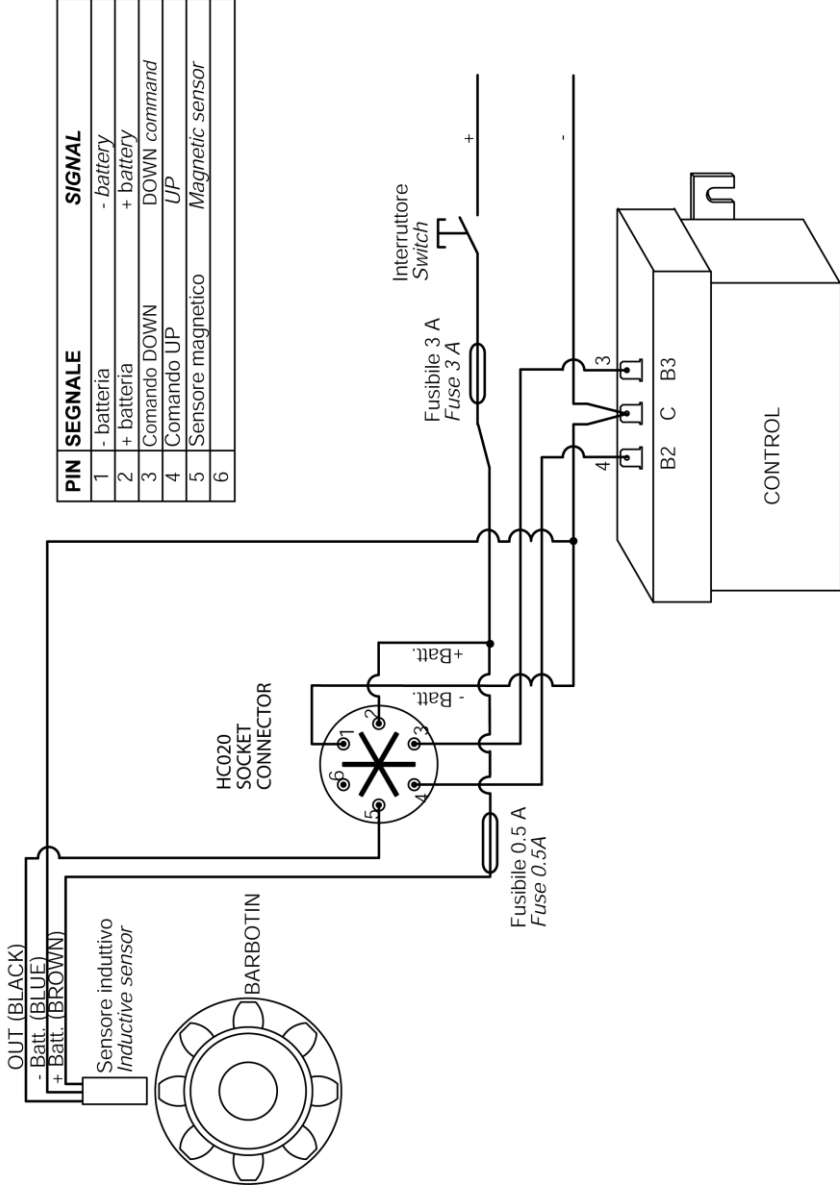

NOTA: Impostare il "Fattore di divisione" per un corretto funzionamento del sensore (vedere men Calibrazione Sensore)

NOTE: Set the "Division Factor" parameter in order to get a correct chain length (see the "Sensor Calibration" men)





**MZ ELECTRONIC S.R.L.**

[www.mzelectronic.it](http://www.mzelectronic.it)  
e-mail: [info@mzelectronic.it](mailto:info@mzelectronic.it)