



3" - 4" Inline Bilge Blower Instruction Manual

- FR** Manuel d'instructions de ventilateur de cale en ligne de 3 à 4 pouces
- DE** Bedienungsanleitung für 3 - 4 Zoll Inline-Bilgegebläse
- IT** Manuale delle istruzioni per l'estrattore d'aria di sentina in linea di 3" - 4"
- NL** Handleiding 3" - 4" inline-lensventilator
- SE** Användarhandledning för 3" - 4" slagvattensfläkt
- ES** Manual de instrucciones del ventilador de sentina en línea de 3" - 4"



xylem
Let's Solve Water

WARNING Gasoline vapors can explode. Before starting engine, operate blower for four minutes and check engine compartment for gasoline vapors. Run blower when operating below cruising speed.

FR **AVERTISSEMENT** Les vapeurs d'essence peuvent exploser. Avant de démarrer le moteur, faire fonctionner le ventilateur pendant quatre minutes et vérifier que le compartiment du moteur ne contient pas de vapeurs d'essence. En cas de fonctionnement pendant un déplacement à une vitesse inférieure à la vitesse de croisière, laisser le ventilateur en marche.







DE **WARNHINWEIS** Benzindämpfe stellen eine Explosionsgefahr dar. Vor dem Starten des Motors das Gebläse vier Minuten lang laufen lassen und Motorraum auf Benzindämpfe hin prüfen. Beim Betrieb unterhalb der Fahrtgeschwindigkeit Gebläse einschalten.

IT **AVVERTENZA** I vapori della benzina possono esplodere. Prima di avviare il motore, azionare l'estrattore d'aria per quattro minuti e controllare il vano del motore per vapori di benzina. Lasciare in funzione l'estrattore d'aria se la velocità di marcia è inferiore a quella di crociera.

NL **WAARSCHUWING** Benzinedampen kunnen ontploffen. Laat alvorens de motor te starten, de ventilator vier minuten draaien en controleer of er benzinedampen zijn in het motorgedeelte. Laat de ventilator draaien bij bediening onder kruissnelheid.

SE **WARNING** Bensinångor kan explodera. Innan du startar motorn ska du slå på fläkten i fyra minuter och kontrollera motorrummet för bensinånga. Slå på fläkten medan du kör med lägre hastighet än marschfart.

ES **ADVERTENCIA** Los vapores de gasolina pueden explotar. Antes de poner el marcha el motor, haga funcionar el ventilador durante cuatro minutos y verifique que no haya vapores de gasolina en el compartimento. Haga funcionar el ventilador cuando opere por debajo de la velocidad de crucero.

<p>⚠ CAUTION</p> 	<p>Disconnect power from the system before working on the unit to avoid personal injury, damage to the surrounding environment and/or damage to the unit.</p>
<p>⚠ MISE EN GARDE</p> <p>FR</p> 	<p>Déconnecter la source d'alimentation électrique du système avant d'effectuer toute réparation ou entretien pour éviter les blessures et d'endommager l'environnement alentours et/ou l'unité.</p>
<p>⚠ VORSICHT</p> <p>DE</p> 	<p>Zur Vermeidung von Verletzungen, Umgebungs- und/oder Gerätebeschädigung vor jeglichen Arbeiten an der Einheit die Stromzufuhr trennen.</p>
<p>⚠ ATTENZIONE</p> <p>IT</p> 	<p>Per evitare infortuni alla persona, danni all'ambiente circostante e/o all'unità, staccare sempre l'alimentazione dal sistema prima di lavorare sull'unità.</p>
<p>⚠ VOORZICHTIG</p> <p>NL</p> 	<p>Schakel de stroomtoevoer naar het systeem uit voordat u aan de unit begint te werken. Dit om persoonlijk letsel, schade aan de omgeving en/of de unit te voorkomen.</p>
<p>⚠ VAR FÖRSIKTIG</p> <p>SE</p> 	<p>Koppla från strömtillförseln från systemet innan du börjar arbeta på enheten för att undvika personskada, skada på omgivningen och/eller produktskada.</p>
<p>⚠ PRECAUCIÓN</p> <p>ES</p> 	<p>Desconecte la alimentación eléctrica del sistema antes de trabajar en la unidad, a fin de evitar lesiones personales, daños al medio ambiente circundante y/o a la unidad.</p>

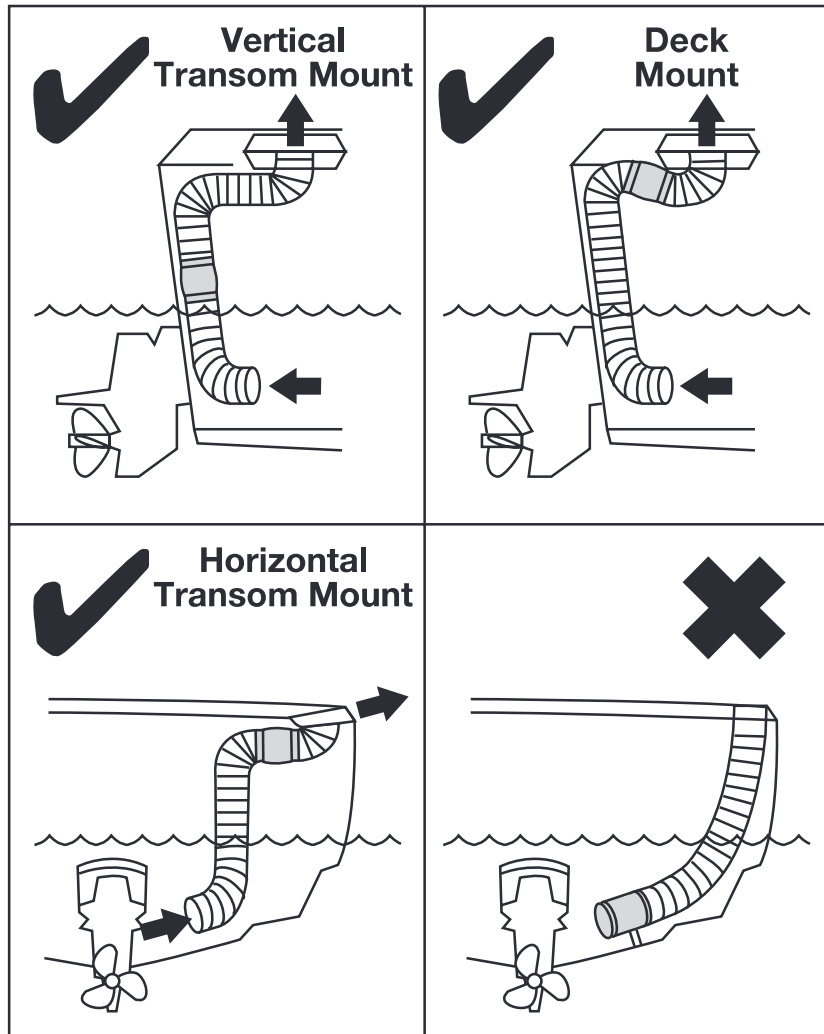

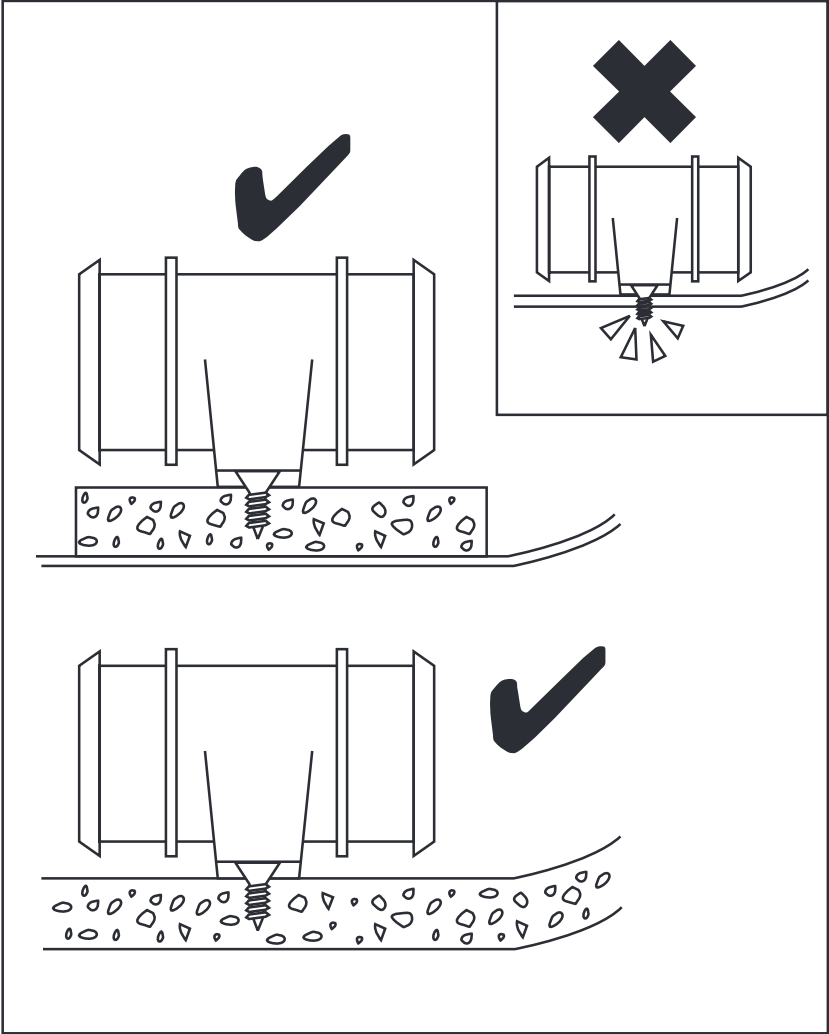

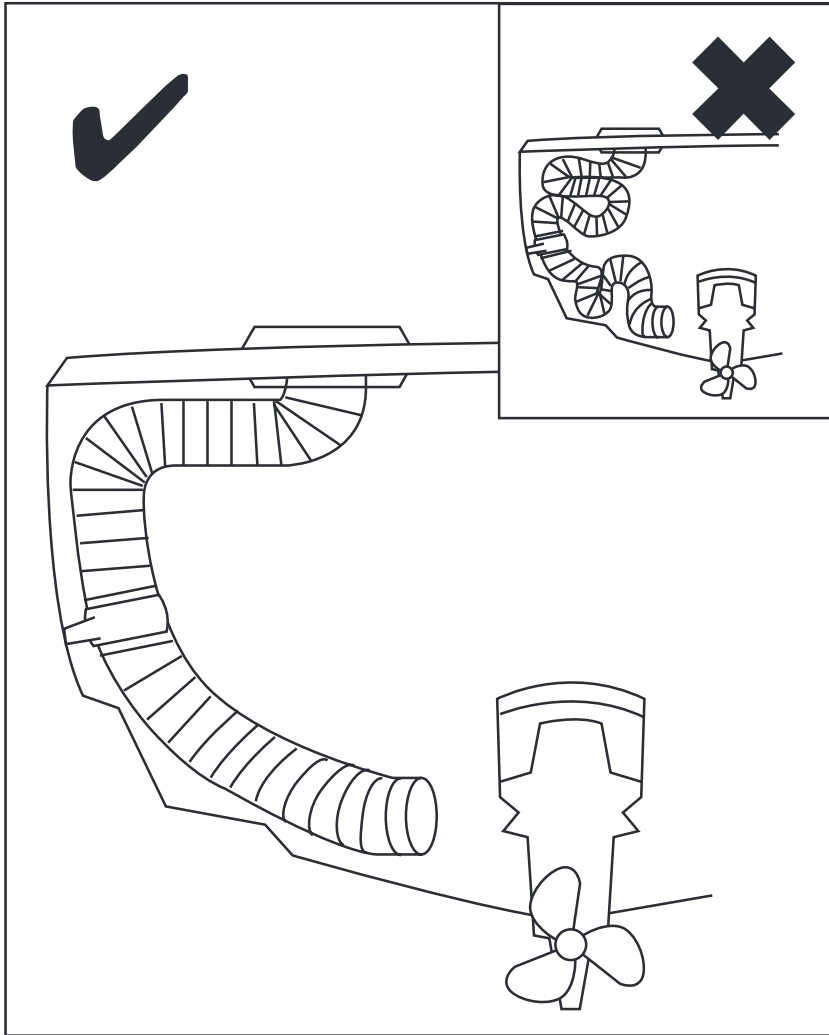

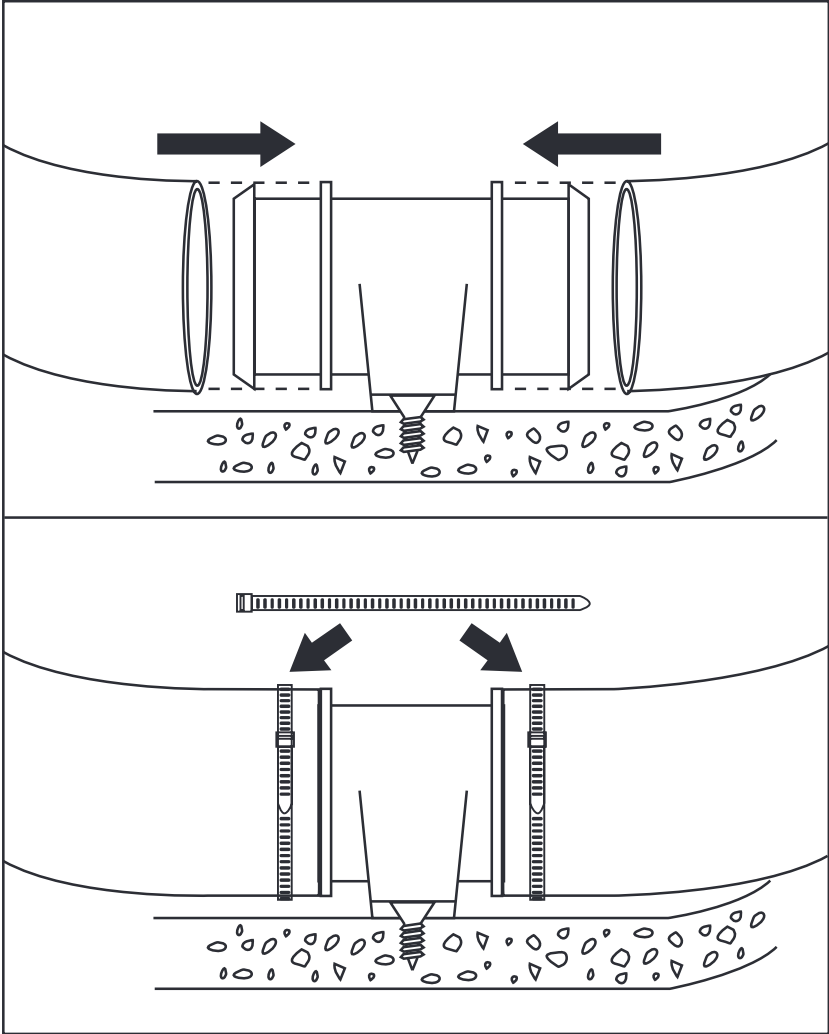

ABCY H2/ISO MARINE

Blower Performance Specifications

Performance at Nominal Voltage

3" Blower	Model 140	12VDC
	Model 140-24V	24VDC

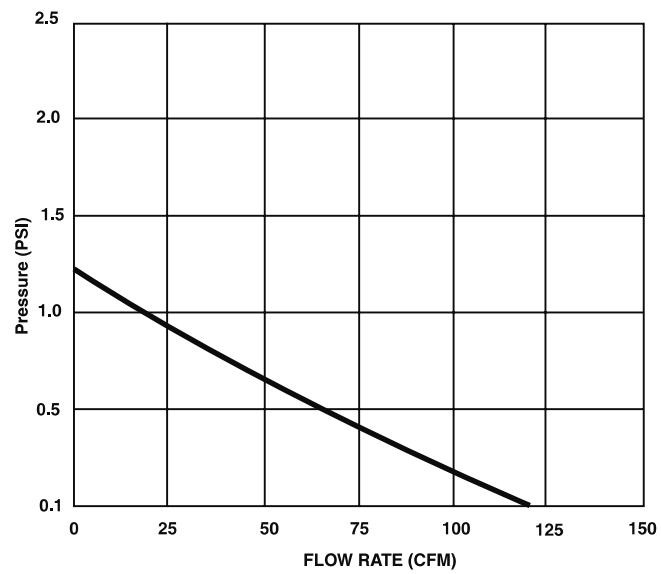

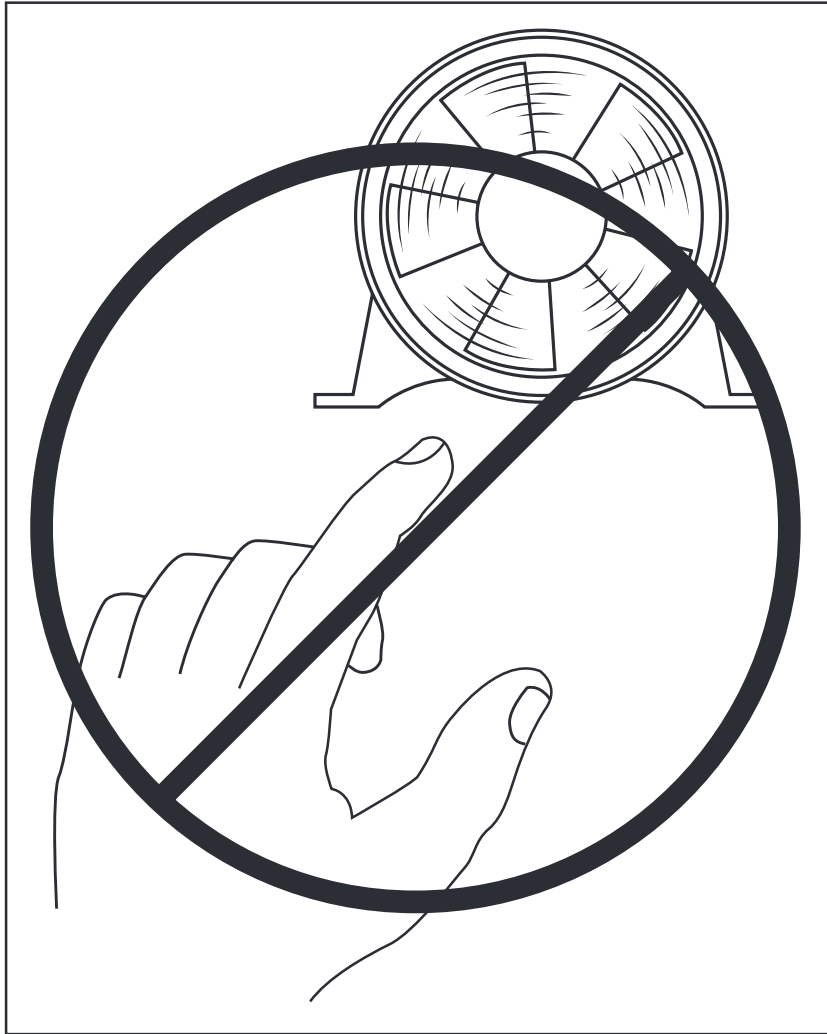

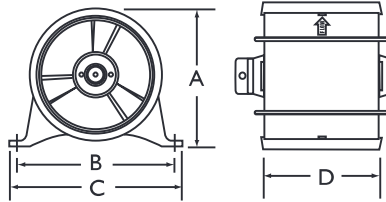

140 & 140-24v		240 & 240-24v	
A	3.75" (95mm)	A	4.75" (121mm)
B	4.5" (114mm)	B	5.5" (140mm)
C	5" (127mm)	C	6" (152mm)
D	3" (76mm)	D	4" (102mm)
E	5.25" (133mm)	E	5.25" (133mm)

All mounting holes must be sealed with a marine grade sealant to prevent water intrusion.



Tous les trous de fixation doivent être rendus étanches à l'aide d'un mastic marine pour éviter toute pénétration d'eau.



Alle Montagebohrungen müssen mit einem für Marineanwendungen geeigneten Dichtmittel abgedichtet werden, um das Eindringen von Wasser zu verhindern.



Per evitare l'intrusione dell'acqua, sigillare tutti i fori di montaggio con un sigillante di qualità marina.



Een zeewatervaste kit moet voor alle montageopeningen gebruikt worden om indringing van zeewater te vermijden.









Alla monteringshål måste förseglas med ett tätningmedel för båtar för att hindra vatten från att tränga in.



Todos los orificios de montaje deben sellarse con un sellador de grado marino para evitar la entrada de agua.



	<p>CAUTION Always install proper fuse size to prevent damage to product should a short occur. Failure to install proper fuse could increase risk of pump malfunction potentially resulting in personal injury and/or fire hazard.</p>
<p>FR</p> 	<p>MISE EN GARDE Toujours installer la taille de fusible appropriée pour éviter d'endommager le produit en cas de court-circuit, faute de quoi la pompe pourrait mal fonctionner et entraîner des blessures et/ou des dangers d'incendie.</p>
<p>DE</p> 	<p>VORSICHT Immer die richtige Sicherungsstärke installieren, um im Fall eines Kurzschlusses eine Beschädigung des Geräts zu vermeiden. Die Verwendung der falschen Sicherungsstärke kann zu einem Versagen der Pumpe und damit möglicherweise zu Verletzungen und/oder Feuergefahr führen.</p>
<p>IT</p> 	<p>ATTENZIONE Per evitare danni al prodotto in caso di cortocircuito, installare sempre fusibile della dimensione corretta. Se viene installato un fusibile scorretto, il rischio di malfunzionamento della pompa aumenta, con il pericolo d'infortunio alla persona e/o d'incendio.</p>
<p>NL</p> 	<p>VOORZICHTIG Monteer altijd de juiste zekering om schade te voorkomen aan het product bij kortsluiting. Nalaten de juiste zekering te installeren, kan het risico op storingen aan de pomp verhogen, met eventueel persoonlijk letsel en/of brandgevaar tot gevolg.</p>
<p>SE</p> 	<p>VAR FÖRSIKTIG Installera alltid rätt säkringsstorlek för att produktskada ifall av kortslutning. Underlåtelse att installera rätt säkring kan öka risken för pumpfel med ris för personskada och/eller brand som resultat.</p>
<p>ES</p> 	<p>PRECAUCIÓN Instale siempre fusibles de tamaño apropiado para evitar daños al producto en caso de cortocircuito. Si no se instala el fusible del tamaño adecuado, puede aumentar el riesgo de fallas de la bomba que pueden ocasionar potencialmente lesiones y/o peligros de incendio.</p>









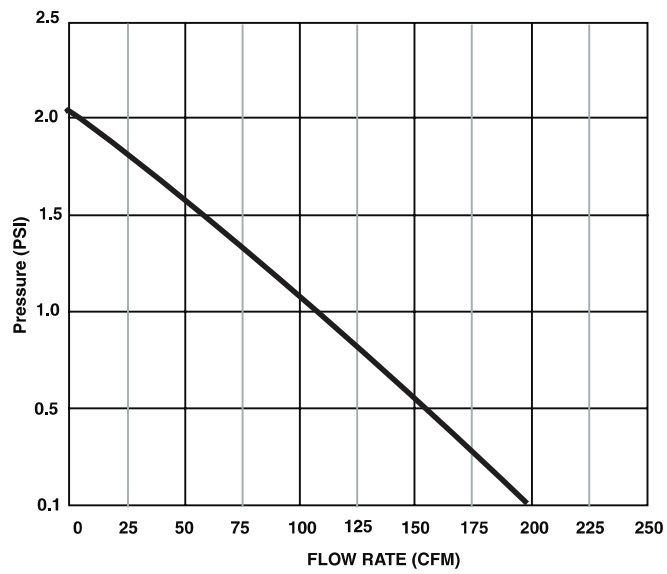



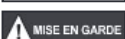

ABCY H2/ISO MARINE

Blower Performance Specifications

Performance at Nominal Voltage

4" Blower	Model 240	12VDC
	Model 240-24V	24VDC



 CAUTION 	<p>Keep all wire connections above the highest water level. Wire connections should be sealed with a marine grade sealant to prevent wire corrosion.</p>
 MISE EN GARDE 	<p>Maintenir tous les raccords électriques au-dessus du niveau d'eau le plus élevé. Tous les raccords électriques devraient être protégés avec du mastic marine afin d'éviter la corrosion des fils.</p>
 VORSICHT 	<p>Darauf achten, dass sich alle Kabelverbindungen stets oberhalb des Wasserspiegels befinden. Drahtverbindungen sollten zum Rostschutz mit einem geeigneten Dichtmittel behandelt werden.</p>
 ATTENZIONE 	<p>Mantenere tutti i collegamenti dei fili elettrici al di sopra del livello più alto dell'acqua. Per evitarne la corrosione, i collegamenti dei fili devono essere sigillati con sigillante specifico per uso marino.</p>
 VOORZICHTIG 	<p>Houd alle draadverbindingen boven het hoogste waterniveau. Dicht de draadverbindingen af met zeewatervaste kit. Dit om corrosie van de draden te voorkomen.</p>
 VAR FÖRSIKTIG 	<p>Håll alla ledningsanslutningar ovanför den högsta vattennivån. Ledningsanslutningarna bör vara förseglade med marint förseglingsmedel för att förhindra korrosion av ledningarna.</p>
 PRECAUCIÓN 	<p>Mantenga todas las conexiones de cables por arriba del máximo nivel del agua. Las conexiones de los cables se deben sellar con un sellador de grado marino para prevenir la corrosión.</p>



When this product carries a CE mark, it conforms to one or more of the following standards:

- EN 61000-6-3 Emissions – Generic Standards (2004)
- EN 55022/B DC Line Conducted Emissions, 0,15MHz – 30MHz (2006)
- EN 55022/B Radiated Emissions, 30MHz – 1,000MHz (2006)
- EN 61000-6-1 Immunity testing for this device is not required as the EUT is a simple electric motor and has no components that might be susceptible to the Immunity Test required by the standard. Clause 8/EN 61000-6-1:2001 determined from consideration of the electrical characteristics and usage of a particular apparatus that some of the tests are inappropriate and therefore unnecessary.

ISO 8846 / Electrical Devices Protection Against Ignition of Surrounding Flammable Gases

Following the Provisions of the Electromagnetic Compatibility Directive 2004 / 108 / EN



Install to ABYC standards H-2 and E11

- FR** Installation conformément aux normes H-2 et E11 de ABYC.
- DE** In Übereinstimmung mit den ABYC-Normen H-2 und E-11 installieren.
- IT** Installare secondo gli standard ABYC H-2 e H-11.
- NL** Installeren volgens ABYC normen H-2 en E11
- SE** Installera i enlighet med ABYC-standard H-2 och E11.
- ES** Instalar según las normas H-2 y E11 del ABYC.

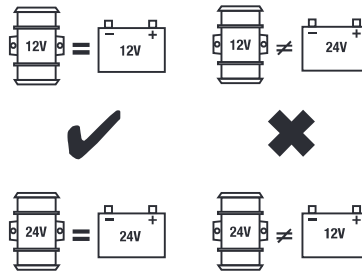

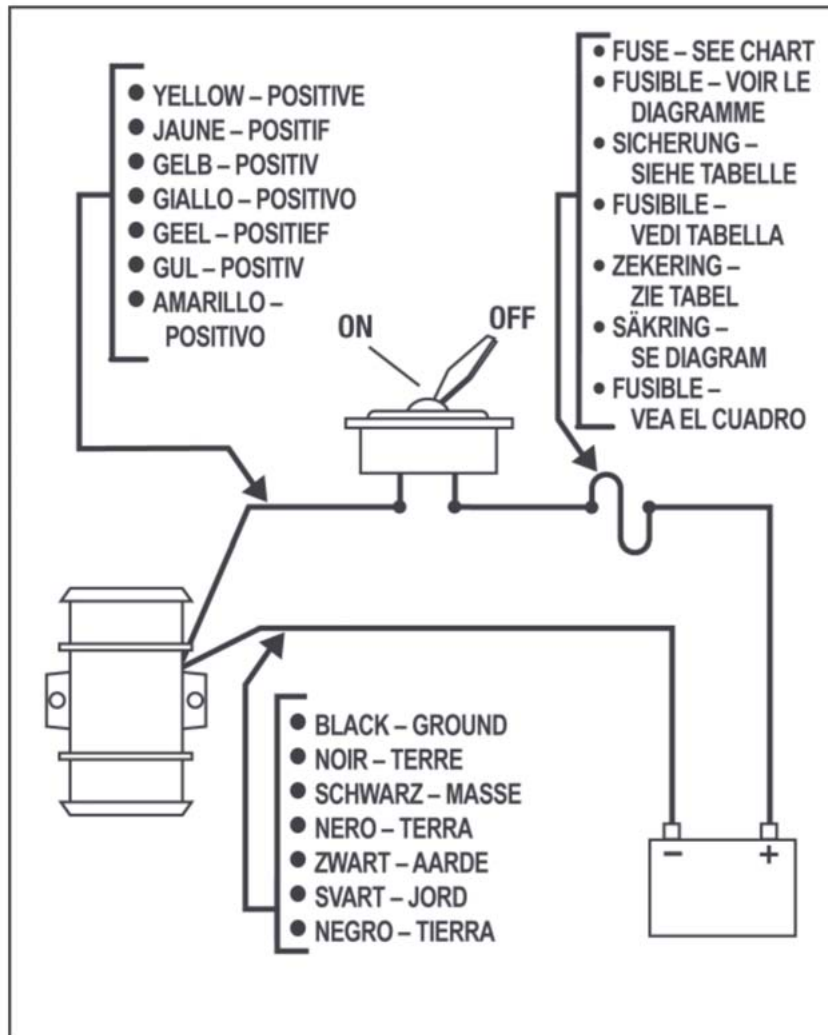

	A	B	C	D	E
	Model	Voltage	Duct Diameter	Amp Draw	Fuse Size
(FR)	Modèle	Tension	Diamètre de tuyau	Tirage amp.	Taille de fusible
(DE)	Modell	Spannung	Schlauchdurchmesser	Leistungsaufnahme	Sicherungsstärke
(IT)	Modello	Tensione	Diametro del condotto	Ampere assorbito	Dimensione fusibile
(NL)	Model	Spanning	Kokerdiameter	Amp. stoot	Zekering
(SE)	Modell	Spänning	Rördiameter	Strömförbrukning	Säkringstorlek
(ES)	Modelo	Voltaje	Diámetro del conducto	Consumo	Tamaño del fusible

	A	B	C	D	E
140	13.6v	3" (75mm)	2.9A	4A	
140-24V	27.2v	3" (75mm)	1.7A	2.5A	
240	13.6v	4" (100mm)	4.3A	7.5A	
240-24V	27.2v	4" (100mm)	2.4A	4A	

xylem
Let's Solve Water

U.S.A. + 1 978 281 0440

UNITED KINGDOM +44 (0) 1992 450 145

JAPAN +81 (0) 45 475 8906

GERMANY +49 (0) 40 53 53 73 0

ITALY +39 039 6852323

For a copy of the warranty, visit www.rule-industries.com

© 2013 Xylem, Inc.

950-0522 Rev. C 1/2013